

IM2065
09/2015
REV03

ASPECT™ 300

OPERATOR'S MANUAL



ENGLISH



Lincoln Electric Bester Sp. z o.o.
ul. Jana III Sobieskiego 19A, 58-263 Bielawa, Poland
www.lincolnelectric.eu

Declaration of conformity



Lincoln Electric Bester Sp. z o.o.

Declares that the welding machine:

ASPECT™ 300

conforms to the following directives:

2006/95/CEE, 2004/108/CEE

and has been designed in compliance with the
following standards:

EN 60974-1:2012, EN 60974-10:2014



24.10.2013

Paweł Lipiński
Operations Director

Lincoln Electric Bester Sp. z o.o., ul. Jana III Sobieskiego 19A, 58-263 Bielawa, Poland

12/05



12/05

THANKS! For having chosen the QUALITY of the Lincoln Electric products.

- Please Examine Package and Equipment for Damage. Claims for material damaged in shipment must be notified immediately to the dealer.
- For future reference record in the table below your equipment identification information. Model Name, Code & Serial Number can be found on the machine rating plate.

Model Name:	
.....	
Code & Serial number:	
.....
Date & Where Purchased:	
.....

ENGLISH INDEX

Technical Specifications.....	1
Electromagnetic Compatibility (EMC).....	2
Safety	3
Installation and Operator Instructions	4
WEEE	22
Spare Parts	22
Electrical Schematic.....	22
Suggested Accessories.....	22

Technical Specifications

INPUT							
Input Voltage U_1					EMC Class	Frequency	
230 - 400Vac \pm 15%					A	50/60 Hz	
Input Line	Mode	35%	60%	100%	Input Amperes I_{1max}	PFmax	
230Vac	STICK	10.3kW	8.8 kW	7kW	27.4 A	0.94	
	TIG DC	8.8kW	6.3 kW	4.9 kW			
	STICK AC	9.6kW	8.3kW	6.9kW			
	TIG AC	8.2kW	6.2kW	4.8kW			
400Vac	STICK	10.3-kW	8.7 kW	7kW	16 A	0.91	
	TIG DC	8.8kW	6.3 kW	4.9-kW			
	STICK AC	9.6kW	8.4 kW	6.8kW			
	TIG AC	8.2kW	6.2 kW	4.8kW			
RATED OUTPUT							
		Output Current I_2 Duty Cycle at % <small>(based on a 10 min. period)</small>			Output Voltage U_2 Duty Cycle at % <small>(based on a 10 min. period)</small>		
Input Line	Mode	35%	60%	100%	35%	60%	100%
230Vac/400Vac 3ph	STICK DC	270A	240A	200A	30.8V	29.6V	28V
	TIG DC	300A	240A	200A	22V	19.6V	18V
	STICK AC	270A	240A	200A	30.8V	29.6V	28V
	TIG AC	300A	240A	200A	22V	19.6V	18V
OUTPUT RANGE							
Welding Current Range				Open Circuit Voltage OCV U_0			
2 – 300A				90 Vdc			
RECOMMENDED INPUT CABLE AND FUSE SIZES							
Fuse (time delayed) or Circuit Breaker Size				Input Power Cable			
16A@400Vac – 32A@ 230Vac				4x4mm ²			
DIMENSIONS AND WEIGHT							
Height	Width	Length		Net Weight			
535 mm	301 mm	632 mm		42 Kg			
Operating Temperature	Storage Temperature	Operating Humidity (t=20°C)		Protection Degree			
-10°C to +40°C	-25°C to 55°C	Not Applicable		IP23			

Electromagnetic Compatibility (EMC)

01/11

This machine has been designed in accordance with all relevant directives and standards. However, it may still generate electromagnetic disturbances that can affect other systems like telecommunications (telephone, radio, and television) or other safety systems. These disturbances can cause safety problems in the affected systems. Read and understand this section to eliminate or reduce the amount of electromagnetic disturbance generated by this machine.



This machine has been designed to operate in an industrial area. The operator must install and operate this equipment as described in this manual. If any electromagnetic disturbances are detected the operator must put in place corrective actions to eliminate these disturbances with, if necessary, assistance from Lincoln Electric. The Class A equipment is not intended for use in residential locations where the electrical power is provided by the public low-voltage supply system. There may be potential difficulties in ensuring electromagnetic compatibility in those locations, due to conducted as well as radiated disturbances. This equipment complies with IEC 61000-3-12 provided that the short-circuit power S_{sc} is greater than or equal to 2227kVA at the interface point between the user's supply and the public system. It is the responsibility of the installer or user of the equipment to ensure, by consultation with the distribution network operator if necessary, that the equipment is connected only to a supply with a short circuit power S_{sc} greater than or equal to 2227kVA.

Before installing the machine, the operator must check the work area for any devices that may malfunction because of electromagnetic disturbances. Consider the following.

- Input and output cables, control cables, and telephone cables that are in or adjacent to the work area and the machine.
- Radio and/or television transmitters and receivers. Computers or computer controlled equipment.
- Safety and control equipment for industrial processes. Equipment for calibration and measurement.
- Personal medical devices like pacemakers and hearing aids.
- Check the electromagnetic immunity for equipment operating in or near the work area. The operator must be sure that all equipment in the area is compatible. This may require additional protection measures.
- The dimensions of the work area to consider will depend on the construction of the area and other activities that are taking place.

Consider the following guidelines to reduce electromagnetic emissions from the machine.





- Connect the machine to the input supply according to this manual. If disturbances occur it may be necessary to take additional precautions such as filtering the input supply.
- The output cables should be kept as short as possible and should be positioned together. If possible connect the work piece to ground in order to reduce the electromagnetic emissions. The operator must check that connecting the work piece to ground does not cause problems or unsafe operating conditions for personnel and equipment.
- Shielding of cables in the work area can reduce electromagnetic emissions. This may be necessary for special applications.



WARNING

This equipment must be used by qualified personnel. Be sure that all installation, operation, maintenance and repair procedures are performed only by qualified person. Read and understand this manual before operating this equipment. Failure to follow the instructions in this manual could cause serious personal injury, loss of life, or damage to this equipment. Read and understand the following explanations of the warning symbols. Lincoln Electric is not responsible for damages caused by improper installation, improper care or abnormal operation.

	<p>WARNING: This symbol indicates that instructions must be followed to avoid serious personal injury, loss of life, or damage to this equipment. Protect yourself and others from possible serious injury or death.</p>
	<p>READ AND UNDERSTAND INSTRUCTIONS: Read and understand this manual before operating this equipment. Arc welding can be hazardous. Failure to follow the instructions in this manual could cause serious personal injury, loss of life, or damage to this equipment.</p>
	<p>ELECTRIC SHOCK CAN KILL: Welding equipment generates high voltages. Do not touch the electrode, work clamp, or connected work pieces when this equipment is on. Insulate yourself from the electrode, work clamp, and connected work pieces.</p>
	<p>ELECTRICALLY POWERED EQUIPMENT: Turn off input power using the disconnect switch at the fuse box before working on this equipment. Ground this equipment in accordance with local electrical regulations.</p>
	<p>ELECTRICALLY POWERED EQUIPMENT: Regularly inspect the input, electrode, and work clamp cables. If any insulation damage exists replace the cable immediately. Do not place the electrode holder directly on the welding table or any other surface in contact with the work clamp to avoid the risk of accidental arc ignition.</p>
	<p>ELECTRIC AND MAGNETIC FIELDS MAY BE DANGEROUS: Electric current flowing through any conductor creates electric and magnetic fields (EMF). EMF fields may interfere with some pacemakers, and welders having a pacemaker shall consult their physician before operating this equipment.</p>
	<p>CE COMPLIANCE: This equipment complies with the European Community Directives.</p>
	<p>ARTIFICIAL OPTICAL RADIATION: According with the requirements in 2006/25/EC Directive and EN 12198 Standard, the equipment is a category 2. It makes mandatory the adoption of Personal Protective Equipments (PPE) having filter with a protection degree up to a maximum of 15, as required by EN169 Standard.</p>
	<p>FUMES AND GASES CAN BE DANGEROUS: Welding may produce fumes and gases hazardous to health. Avoid breathing these fumes and gases. To avoid these dangers the operator must use enough ventilation or exhaust to keep fumes and gases away from the breathing zone.</p>
	<p>ARC RAYS CAN BURN: Use a shield with the proper filter and cover plates to protect your eyes from sparks and the rays of the arc when welding or observing. Use suitable clothing made from durable flame-resistant material to protect you skin and that of your helpers. Protect other nearby personnel with suitable, non-flammable screening and warn them not to watch the arc nor expose themselves to the arc.</p>
	<p>WELDING SPARKS CAN CAUSE FIRE OR EXPLOSION: Remove fire hazards from the welding area and have a fire extinguisher readily available. Welding sparks and hot materials from the welding process can easily go through small cracks and openings to adjacent areas. Do not weld on any tanks, drums, containers, or material until the proper steps have been taken to insure that no flammable or toxic vapors will be present. Never operate this equipment when flammable gases, vapors or liquid combustibles are present.</p>
	<p>WELDED MATERIALS CAN BURN: Welding generates a large amount of heat. Hot surfaces and materials in work area can cause serious burns. Use gloves and pliers when touching or moving materials in the work area.</p>

	SAFETY MARK: This equipment is suitable for supplying power for welding operations carried out in an environment with increased hazard of electric shock.
	EQUIPMENT WEIGHT OVER 30kg: Move this equipment with care and with the help of another person. Lifting may be dangerous for your physical health.
	CYLINDER MAY EXPLODE IF DAMAGED: Use only compressed gas cylinders containing the correct shielding gas for the process used and properly operating regulators designed for the gas and pressure used. Always keep cylinders in an upright position securely chained to a fixed support. Do not move or transport gas cylinders with the protection cap removed. Do not allow the electrode, electrode holder, work clamp or any other electrically live part to touch a gas cylinder. Gas cylinders must be located away from areas where they may be subjected to physical damage or the welding process including sparks and heat sources.
HF	CAUTION: The high frequency used for contact-free ignition with TIG (GTAW) welding, can interfere with the operation of insufficiently shielded computer equipment, EDP centers and industrial robots, even causing complete system breakdown. TIG (GTAW) welding may interfere with electronic telephone networks and with radio and TV reception.
	NOISE APPEARES DURING WELDING CAN BE HARMFUL: Welding arc can cause noise with high level of 85dB for 8-hour week day. Welders operating welding machines are obligated to wear the proper ear protectors. Employers are obligated to carry examinations and measurements of health harmful factors.

The manufacturer reserves the right to make changes and/or improvements in design without upgrade at the same time the operator's manual.

Installation and Operator Instructions

General description

Aspect™ 300ACDC machine is designated to perform SMAW and GTAW welding process in DC and AC current.

Unit is designed mainly to satisfy GTAW requestes in both DC and AC mode: thanks an advance menu options both beginners and experts welder can adjust welding parameters to have the best welding performances.

Following paragraphs will show how to access to the menu and the parameters tha can be set.

Read this entire section before installation or operation of the machine.

Location and Environment

This machine will operate in harsh environments. However, it is important that simple preventative measures are followed to assure long life and reliable operation.

- Do not place or operate this machine on a surface with an incline greater than 15° from horizontal.
- Do not use this machine for pipe thawing.
- This machine must be located where there is free circulation of clean air without restrictions for air movement to and from the air vents. Do not cover the machine with paper, cloth or rags when switched on.
- Dirt and dust that can be drawn into the machine should be kept to a minimum.
- This machine has a protection rating of IP23. Keep it dry when possible and do not place it on wet ground or in puddles.
- Locate the machine away from radio controlled machinery. Normal operation may adversely affect the operation of nearby radio controlled machinery,

which may result in injury or equipment damage.

Read the section on electromagnetic compatibility in this manual.

- Do not operate in areas with an ambient temperature greater than 40°C.

Input Supply Connection

Check the input voltage, phase, and frequency supplied to this machine before turning it on. The allowable input voltage is indicated in the technical specification section of this manual and on the rating plate of the machine. Be sure that the machine is grounded.

Make sure the amount of power available from the input connection is adequate for normal operation of the machine. The fuse rating and cable sizes are both indicated in the "Technical Specification" section of this manual.

The machines are designed to operate on engine driven generators as long as the auxiliary can supply adequate voltage, frequency and power as indicated in the "Technical Specification" section of this manual. The auxiliary supply of the generator must also meet the following conditions:

400Vac 3 phases:

- Vac peak voltage: below 670V
- Vac frequency: in the range of 50 and 60Hz
- RMS voltage of the AC waveform: 400Vac ± 15%

230Vac 3 phases:



- Vac peak voltage: below 410V
- Vac frequency: in the range of 50 and 60Hz
- RMS voltage of the AC waveform: 230Vac ± 15%

It is important to check these conditions because many

engine driven generators produce high voltage spikes. Operation of this machine on engine driven generators not conforming to these conditions is not recommended and may damage the machine.

Output Connections

A quick disconnect system using Twist-Mate™ cable plugs is used for the welding cable connections. Refer to the following sections for more information on connecting the machine for operation of stick welding (MMA) or TIG welding (GTAW).

	Quick Disconnect: Torch (for MMA and GTAW process) output connector for the welding circuit.
	Quick Disconnect: workpiece output connector for the welding circuit.

Stick Welding (MMA)

This machine does not include a MMA welding kit cables, but may be purchased separately. Refer to the accessories section for more information.

First determine the proper electrode polarity for the electrode to be used. Consult the electrode data for this information. Then connect the output cables to the output terminals of the machine for the selected polarity. Shown here is the connection method for torch.

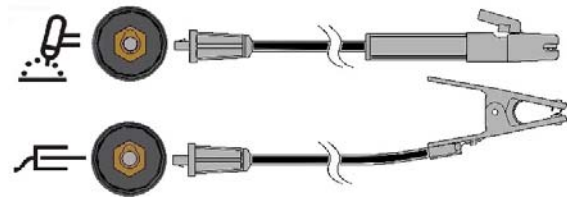

Connect the electrode cable to the torch terminal and the work clamp to the work piece terminal. Insert the connector with the key lining up with the keyway and rotate approximately ¼ turn clockwise. Do not over tighten.

Polarity for Stick can be selected between (DC+, DC-, AC) by front panel push button and menu, see following.

TIG Welding (GTAW)

This machine does not include a TIG torch necessary for TIG welding, but one may be purchased separately. Refer to the accessories section for more information.

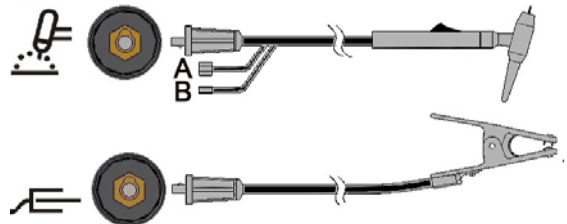

Connect the torch cable to the torch terminal of the machine and the work clamp to the work piece terminal. Insert the connector with the key lining up with the

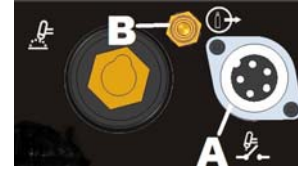

Do not over tighten. Finally, connect the gas hose from the TIG torch to the gas connector (B) on the front of the machine. If necessary, an extra gas connector for the fitting on the front of the machine is included in the package. Next, connect the fitting on the back of the machine to a gas regulator on the cylinder of gas to be used. The required fittings are included in the package. Connect the TIG torch trigger to the trigger connector (A) on the front of the machine.

TIG Welding with a Water Cooled Torch

A cooling unit can be applied to the Machine:

- COOLARC-46

If a Coolarc unit listed above is connected to the Machine, it will be automatically turned ON and OFF in order to ensure the torch cooling. When Stick welding mode is used the cooler will be OFF.

This machine does not include a cooled TIG torch, but one may be purchased separately. Refer to the accessories section for more information.

⚠ WARNING

The Machine is provided with an electrical connection for the Coolarc unit on its rear side. This socket is ONLY for the connection of the Coolarc unit listed above.

⚠ WARNING

Before connecting the cooler unit to the Machine and operate, read and understand the Instruction Manual supplied with the cooling unit.

⚠ WARNING

Connect and disconnect the cooler with the unit switched OFF.

Remote Control Connection

Refer to the accessories section for a list of remote controls. If a remote control is used, it will be connected to the remote connector on the front of the machine.



The machine will automatically detect the remote control, turn on the REMOTE LED, and switch to remote control mode. More information on this mode of operation will be given in the next section.

WIRELESS

Unit can manage also a remote device wireless. To accept this part an auxiliary supply connector to supply wireless device is put on the front of the unit. This supply connector is protect by a plastic cover. See accessory section for details on wireless part number.



Rear Panel

- A. **Power Switch:** It turns ON / OFF the input power to the machine.
- B. **Input cable:** Connect it to the mains.
- C. **Fan:** Do not obstruct or filter the fan inlet. The "F.A.N." (Fan As Needed) feature automatically turns OFF/ON the fan. When the Machine is turned ON the fan is turned ON only for the startup time (few seconds). The fan will start with welding operations and will continue to run whenever the Machine is welding. If the Machine doesn't weld for more than 10minutes, it will go in Green Mode.

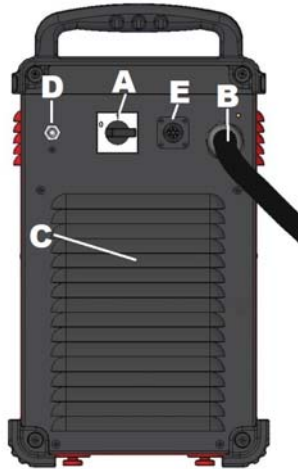

Green Mode

The Green Mode is a feature that puts the machine in a stand-by condition:

- The output is disabled
- The fans are speed down
- Only the Power ON LED remains ON.
- Display show the dash char

This reduces the amount of dirt that can be drawn inside the Machine and the power consumption.

To restore the Machine restart to weld or push the TIG trigger or push any buttons in the front panel or turn the encoder knob.

NOTE: If a COOLARC TIG torch cooling unit is connected to the machine, it will be turned ON/OFF by the Green Mode feature based also on COOL option. See Menu SYS section for more details.

Idle Mode

After 30 minutes without welding the machine will enter a deep low power mode. It will shut down all indicators: only Power ON Led is blinking.

To restore the Machine push the trigger or push any buttons in the front panel or turn the encoder Exit procedure will take 6-7s: after this time the unit is ready to weld.

- D. **Gas Inlet:** Connector for the TIG shielding gas. Use the supplied connector to connect the machine to the gas source line. The gas source must have a pressure regulator and flow gage installed.
- E. **Power supply socket for Coolarc:** 400Vac socket. Connect here the Coolarc cooling unit.

Controls and Operational Features

Machine Start-Up:

When the machine is turned ON an auto-test is executed.

The Machine is ready to operate when on the Front Control Panel lights up the "Power ON" LED, the "A" LED (placed on the middle of the synoptic) with one of the LED of the Welding "MODE" command. This is the minimum condition: depending by the welding selection others LEDs may be ON.

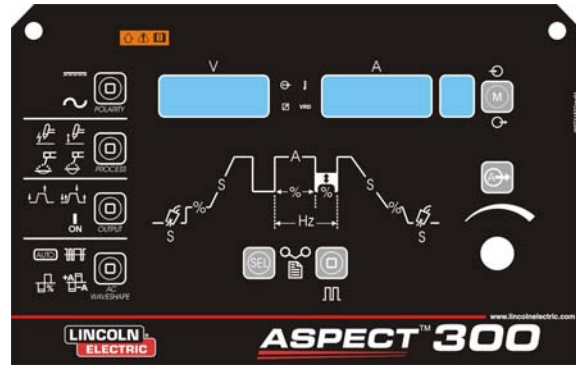

Front Panel Indicators and Controls

Power ON LED:



This LED blinks during the machine start-up or during restart after idle mode and lights up steadily when the machine is ready to operate.

If the Input Voltage Overrange protection becomes active, the Power ON LED starts blinking and an error code is shown on the displays. The machine restarts automatically when the Input Voltage returns in the correct range. For further detail read the Error Codes and Troubleshooting section.

If the trigger is pushed before the unit is ready to weld, or after a weld is completed in GTAW mode, the Power ON LED will blink at a fast rate. Release the trigger to restore normal operation.

Remote LED:



This indicator will turn on when a Remote command is connected to the machine via the remote control connector.

If a Remote command is connected to the Machine, the Output Current knob operates in two different modes: STICK and TIG:

- **STICK mode:** with a Remote command connected the output of the machine is ON. A Remote Ampctrl or Pedal are allowed (trigger is ignored).



Connecting the Remote command excludes the Output Current Knob of the Machine's user interface. Through the Remote command is available the full Output Current Range.

- **TIG mode:** in Local and remote mode the output of the machine is OFF. A Trigger is necessary to enable the output.

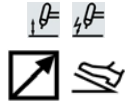

The Output Current range selectable from the Remote command depends by the Machine's user interface Output Current Knob. Eg.: if the Output Current is set to 100A with the Machine's user interface Output Current Knob, the Remote command will adjust the Output Current from a minimum of 5A to a maximum of 100A.

Remote Pedal: For a correct use, the "Menu GTAW" and "Menu SYS" must be enabled in the setup menu:

- 2-step sequence is automatically selected
- Upslope / Downslope ramps and Restart are disabled.
- Spot, Bi-Level and 4-step functions aren't selectable

(Normal operation is restored when the Remote command is disconnected.)

Thermal LED:



This indicator will turn on when the machine is overheated and the output has been disabled. This normally occurs when the duty cycle of the machine has been exceeded. Leave the machine on to allow the internal components to cool. When the indicator turns off, normal operation is again possible.

VRD LED (enabled on Australian Machines only):



This machine is provided by VRD (Voltage Reduction Device) function: this reduces the voltage at the output leads.

The VRD function is enabled by factory default only on machines that meet the AS 1674.2 Australian Standards. (C-Tick logo "C" on/near the Rating Plate applied on the machine).

The VRD LED is ON when the Output Voltage is below 12V with the Machine at idle (no welding time).

For others machines (CE & USA) this function is abled into Menu SYS.

Polarity:



This icon is designated to set the polarity of the process in use: DC+, AC stick, DC- & AC TIG operations.

NOTE: Pressing the button assigned to process POLARITY will toggle the illumination of the icon between DC & AC polarity.

Process:



The function of this icon is to allow the user to set the determined process.

1. High-Frequency TIG
2. Lift-Start TIG
3. Stick – Soft Mode (7018 style electrodes)
4. Stick- Crisp Mode (6010 Style electrodes)

NOTE: Arc control parameters, Hot start and arc force parameters, are different in two stick modes. In menu SMAW is possible to change hot start and arc force diagram.

NOTE: Pressing the button assigned to PROCESS selection will toggle the illumination of the icon from left-to-right following the progression of the numbers.

Output:

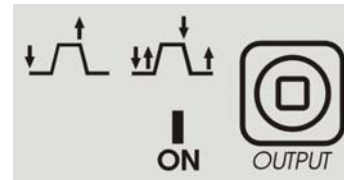

This section is designated to allow the operator to set the desired output control method

1. 2 STEP
2. 4 STEP
3. ON: no trigger required to start.



Pressing the button assigned to OUTPUT selection will toggle the illumination of the icon from left-to-right

AC Wave Shape:



These icons allow the operator to customize the arc performance for TIG welding in AC polarity only. AUTO and Expert Mode:
By default the AUTO icon is lit. This means that AC waveshape parameters are automatically managed depending on the welding current. The only available parameter is AC-Frequency.
 AC-Frequency: This function controls the frequency of the AC Wave shape in cycles per second

To enable Expert mode:

- Push the AC WAVESHAPE button twice: The AUTO icon will start to blink and the display will show the message AUTO ON.
- Turn the encoder to select AUTO OFF
- Confirm the selection by pushing the AC WAVESHAPE button again. The AUTO icon will turn OFF and all the AC WAVESHAPE parameters will become available.

To revert to AUTO mode perform again the steps above pushing several times until AUTO icon will start blinking, then select AUTO ON with the encoder.

In Expert mode the following parameters are available:

1. AC-Frequency: This function controls the frequency of the AC Wave shape in cycles per second.
2. AC-Balance: AC balance controls the amount of time, as a percentage, that the polarity is electrode negative.
3. Electrode Negative/Positive offset: This function controls the amperage setting for the negative and positive side of the wave when TIG welding in AC polarity.

The voltage display screen shows an abbreviated description of the icon selected. The amperage display screen shows the value to be adjusted.

Sequencer Functions:

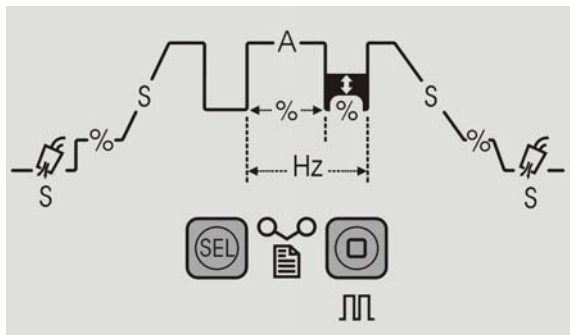

The sequencer allows for the customization of the TIG welding operation both in AC & DC- polarities. Pressing

the "Sel" button will cycle through the process graph.

	Pre-Flow: Sets the time in seconds gas will flow prior to arc-start initiation
	Starting Current: Sets the starting amperage for the process.
	Initial Slope: Sets the time in seconds it takes the starting current to reach normal operating amperage.
	Operating Amperage: Sets the amperage for all welding process permitted.
	Final Slope: Sets the time in seconds it takes the operating amperage to ramp down to the Finishing current.
	Finishing Current: Sets the finishing amperage for the process.
	Post Flow: Sets the time in seconds gas will flow after the arc is terminated

Pulse Sequencer Functions:



	Percent Peak Current: This functions sets the amount of time the pulse waveform spends at the peak current setting. This function is set as a percentage of the total time for the pulse cycle.
	Pulses-Per-Second: Sets the total number of pulse cycles per second of time.
	Percent Background Current: Sets the background amperage of the pulse waveform. Background amperage is set as a percentage of the peak current.

Main Amperage Control:

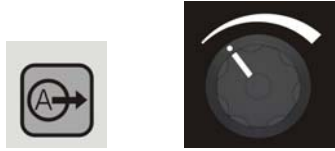

The main amperage control button is intended to be a quick selection method to adjust the main amperage setting. This function will allow users to quickly exit the sequencer portion of the U/I, eliminating the need to cycle through all possible sequencer functions to adjust the main amperage or exit the sequencer menu.

This knob is also a multi-purpose command: see the "Operating Instruction" section for a description of how to use this command for parameter selection.

Displays:



The right meter displays the preset welding current (A) before welding and the actual welding current during welding, and the left meter shown the voltage (V) at the output leads.

A flashing on both displays indicate that the value read is the average value of the previous welding operation. This feature shown the average value for 5seconds after every welding time.

If a remote control is connected (the Remote LED is ON), the left meter (A) indicates the preset and the actual welding current following the instruction explained in the "Remote LED" description above.

The displays are used to indicate during setting of parameters, the name and the value of them. Also are used for menu indication and error codes displaying.

Memory Selection:

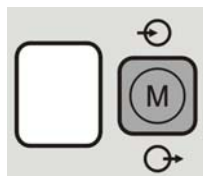

The memory function is designed to allow the operator to save up to 9 specific welding procedures. This memory button will have two functions:

1. Save memory settings
2. Recall memory settings.

Selecting Memory Functions: Pressing the memory button will allow the user to toggle between "saving" a memory, "recalling" a memory or operating without using a memory setting.

1. Pushing 1 time "M" icon, SAVE icon turned on.
2. Pushing 2 times "M" icon, RECALL icon turned on.
3. Pushing 3 times Icon and displays turn off.

Saving Memory Settings:

In order to save process settings into a memory location it is first necessary to press the memory button so that the "memory save" icon is highlighted. Once highlighted, the number on the screen will flash to indicate this number can be changed by turning the control knob below, and the voltage and amperage meters will say "MEM SET". Once the desired memory location has been selected using the control knob, pressing and holding the memory button for 3 seconds will save the settings in that location. During the 3 second hold period the "memory save" icon will flash. After 3 seconds the displays will show "MEM SAVE"

OPERATION:

- 1.) Press Memory button to highlight "Memory Save" icon;
- 2.) Turn Control Knob to Select memory location;
- 3.) Press and hold memory button for 3 seconds.

Recalling Memory Settings:

In order to recall process settings it is first necessary to press the memory button so that the "memory recall" icon is highlighted. Once highlighted, the number on the screen will flash to indicate this number can be changed by turning the control knob below, and the voltage and amperage meters will say "MEM RECL". Once the desired memory location has been selected using the control knob, pressing and holding the memory button for 3 seconds will recall the settings from that location. During the 3 second hold period the "memory recall" icon will flash. After 3 seconds the displays will show "RECL MEM"

OPERATION:

- 1.) Press Memory button to highlight "Memory Recall" icon.
- 2.) Turn Control Knob to Select memory location.
- 3.) Press and hold memory button for 3 seconds.

Menu:

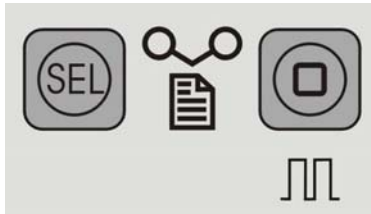

This unit permits an advance setting divided in 3 menu:

- 1.) Press and Hold for 5 seconds to access setup menu "GTAW".
- 2.) Press and Hold for 5 seconds to access setup menu "SMAW".
- 3.) Press and Hold + for 5 seconds to access setup menu "SYS".
- 4.) Upon entering one of the three menus , "GTAW", "SMAW", or "SYS", menu progression is

accomplished by pressing . While moving backward is accomplished by pressing .

- 5.) Changes to menu items will be accomplished by



using the Control Knob.

- 6.) After an item is changed it will be saved if or is pressed.

- 7.) Each menu can be exited by pressing .

Operating Instruction

DC Stick (SMAW) Welding

To start DC Stick welding process:

- 1.) Set polarity
- 2.) To select Stick welding:

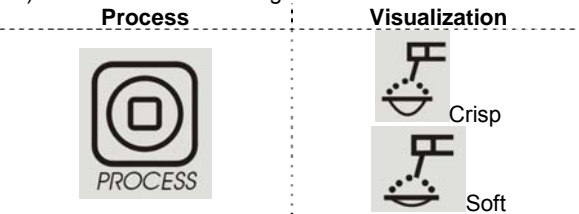

Press MODE several times until the LED above lights up

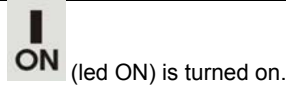

- When the Stick position is selected, the following welding features are enabled:
- Hot Start: This is a temporary increase in the output current during the start of the stick welding process. This helps ignite the arc quickly and reliably.
 - Anti-Sticking: This is a function which decreases

the output current of the machine to a low level when the operator makes an error and sticks the electrode to the work piece. This decrease in current allows the operator to remove the electrode from the electrode holder without creating large sparks which can damage the electrode holder.

- Auto Adaptive Arc Force: this function increases temporary the output current, used to clear intermittent connections between the electrode and the weld puddle that occur during stick welding.

This is an active control feature that guarantees the best arrangement between the arc stability and spatter presence. The feature "Auto Adaptive Arc Force" has instead of a fixed or manual regulation, an automatic and multilevel setting: its intensity depends by the output voltage and it is calculated in real time by the microprocessor where are also mapped the Arc Force levels. The control measure in each instant the output voltage and it determines the amount of the peak of current to apply; that value is enough to breaks the metal drop that is being transferred from the electrode to the workpiece as to guarantee the arc stability, but not too high to avoid spatters around the welding puddle. That means:

- Electrode / workpiece sticking prevention, also with low current values.
- Spatters reduction.

The welding operations are simplified and the welded joints looks better, also if not brushed after the welding.

In Stick mode, two different setup are available, and they are completely separate into Process setup:

- SOFT Stick: For a welding with a low spatter presence.
- CRISP Stick (Factory Default): For an aggressive welding, with an increased Arc stability.

For default the polarity is DC+. To change in DC- see menu SMAW operation section.

See menu SMAW to change value of hot start and arc force.

AC Stick Welding

To start AC Stick welding process:

- 3.) Set polarity
- 4.) To select Stick welding:

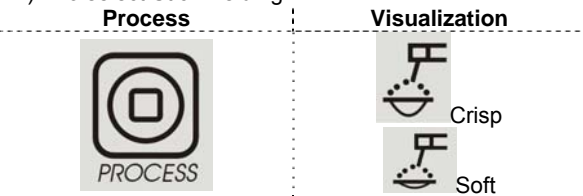

Press MODE several times until the LED above lights up

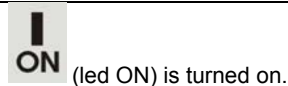

The output current wave form is a 60Hz sinusoidal current with balance 50% without offset. It's not possible to change any parameters of AC Wave.

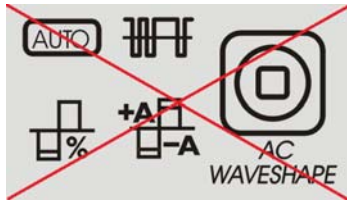

GTAW welding

DC TIG Welding

To start DC Tig welding process:

- 5.) Set polarity
- 6.) To select TIG welding:

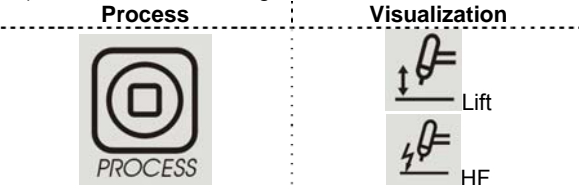

Press MODE several times until the LED above lights up

Led 2T turned on for default.

LIFT TIG

When the mode pushbutton is in the Lift TIG position, the machine is ready for Lift TIG welding. Lift TIG is a method of starting a TIG weld by first pressing the TIG torch electrode on the work piece in order to create a low current short circuit. Then, the electrode is lifted from the work piece to start the TIG arc.

HF TIG

When the mode pushbutton is in HF TIG position, the machine is ready for HF TIG welding. During the HF TIG mode, the TIG arc is started by HF without pressing the electrode on the work piece. The HF used for starting the TIG arc will remain on for 3 seconds; if the arc is not started in this time limit, the trigger sequence must be restarted.

NOTE: The HF start strength is adjusted to the tungstenseize and type, which can be selected in menu GTAW.

AC Tig Welding

To start AC Tig welding process:

- 1.) Set polarity
- 2.) To select AC Tig welding:

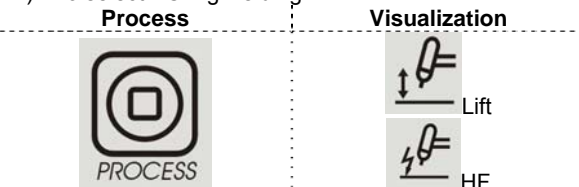

Press MODE several times until the LED above lights up

2T led is turned on for default.

Ac wave shape section is available. About Lift and Tig starting see section above.

Tig Welding Sequences

During no welding operation at each pressure of SEL push button, it's possible to step through all sequencer and set parameters.

During welding the Sel pushbutton is enabled for the following functions:

- Output current
- Only if Pulse Function is active: is possible operates on the values of Duty (%), Frequency (Hz) and Background current (A).

The new parameter value is automatically saved.

TIG Trigger Sequences

TIG welding can be done in either the 2-step or 4-step mode. The specific sequences of operation for the trigger modes are explained below.

Legenda of the symbols used:

	Torch Pushbutton
	Output Current
	Gas Pre-flow
	Gas
	Gas Post-flow

2-Step Trigger Sequence

To select 2-Step sequence:

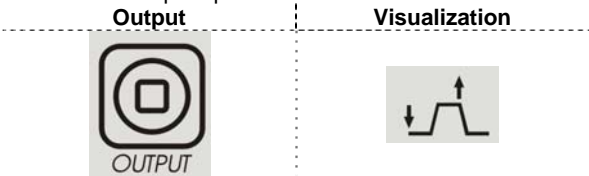

Press several times until the LED above lights up

With the 2-step trigger mode and a TIG welding mode selected, the following welding sequence will occur.

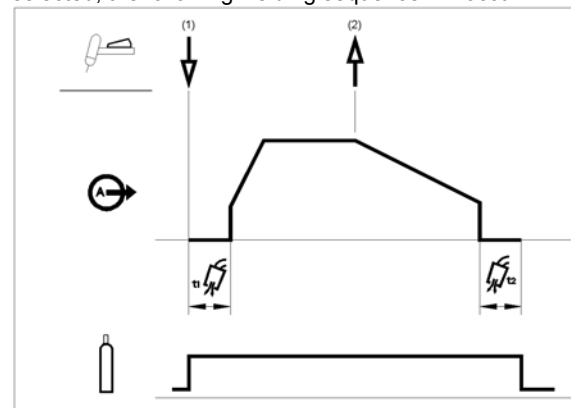

1. Press and hold the TIG torch trigger to start the sequence. The machine will open the gas valve to start the flow of the shielding gas. After the preflow time, to purge air from the torch hose, the output of the machine is turned ON. At this time the arc is started according to the selected welding mode. The initial current is set to 25A for LIFT starting (starting current parameter is disabled in the sequencer) or set according to the Starting current parameter for HF starting. After the arc is started the output current will be increased at a controlled rate, or upslope time, until the Welding current is reached.

If the torch trigger is released during the upslope time the arc will stop immediately and the output of the machine is turned OFF.

2. Release the TIG torch trigger to stop welding. The machine will now decrease the output current at a controlled rate, or downslope time, until the Crater current is reached and the output of the machine is turned OFF.

After the arc is turned OFF, the gas valve will remain open to continue the flow of the shielding gas to the hot electrode and work piece.

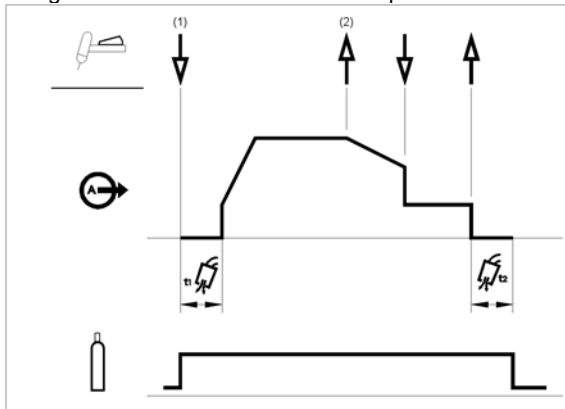

As shown above, it is possible to press and hold the TIG torch trigger a second time during downslope to end the downslope function and maintain the output current at the Crater current. When the TIG torch trigger is released the output will turn OFF and the postflow time will start. This operation sequence, 2-step with restart disabled, is the default setting from the factory.

2-Step Trigger Sequence with Restart Option

To select 2-Step with restart sequence:

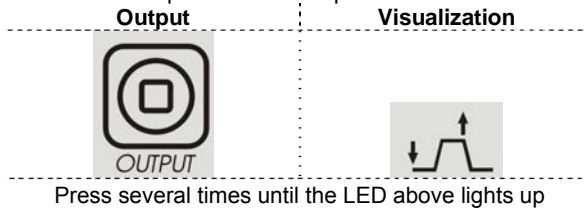

Enter Menu GTAW and enable 2RST option.

If the 2-step restart option is enabled from the setup menu the following sequence will occur:

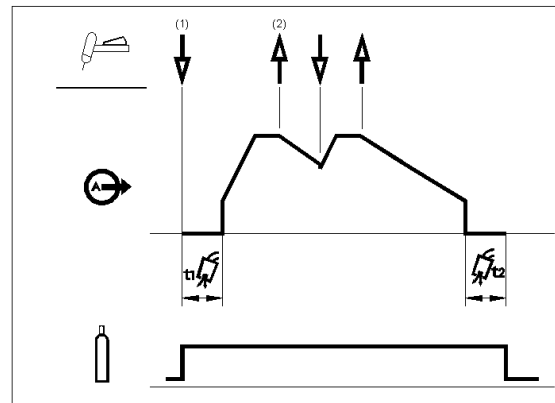

1. Press and hold the TIG torch trigger to start the sequence as described above.
2. Release the TIG torch trigger to start the downslope. During this time press and hold the TIG torch trigger to restart welding. The output current will increase again at a controlled rate until the Welding current is reached. This sequence can be repeated as many times as necessary. When the welding is complete release the TIG torch trigger. When the Crater current is reached the output of the machine is turned OFF.

4-Step Trigger Sequence

To select 4-Step sequence:

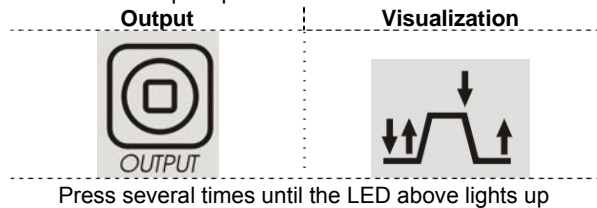

With the 4-step trigger mode and a TIG welding mode selected, the following welding sequence will occur.

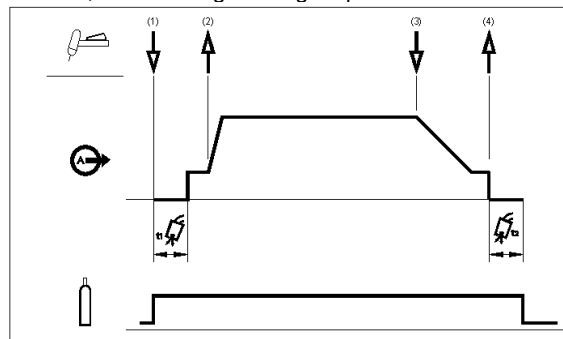

1. Press and hold the TIG torch trigger to start the sequence. The machine will open the gas valve to start the flow of the shielding gas. After the preflow time, to purge air from the torch hose, the output of the machine is turned ON. At this time the arc is started according to the selected welding mode. In LIFT starting the touching current is 25A until the short circuit is removed. After the arc is started the output current will be at the Start current. This condition can be maintained as long as necessary.

If the Start current is not necessary, do not hold the TIG torch trigger as described at the beginning of this step. In this condition, the machine will pass from Step 1 to Step 2 when the arc is started.

- Releasing the TIG torch trigger starts the upslope function. The output current will be increased at a controlled rate, or upslope time, until the Welding current is reached. If the torch trigger is pushed during the upslope time the arc will stop immediately and the output of the machine is turned OFF.
- Press and hold the TIG torch trigger when the main part of the weld is complete. The machine will now decrease the output current at a controlled rate, or downslope time, until the Crater current is reached.
- This Crater current can be maintained as long as necessary. When the TIG torch trigger is released the output of the machine is turned OFF and the postflow time will start.

As shown here, after the TIG torch trigger is quickly pressed and released from step 3A, it is possible to press and hold the TIG torch trigger another time to end the downslope time and maintain the output current at the Crater current. When the TIG torch trigger is released the output will turn OFF.

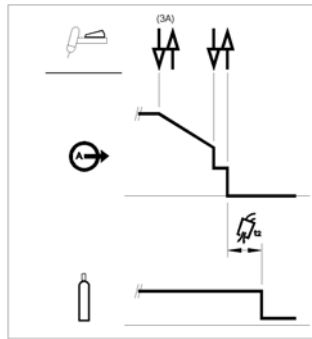

This sequence operation, 4-step with restart disabled, is the default setting from the factory.

4-Step Trigger Sequence with Restart Option

To select 4-Step with restart sequence:

Output	Visualization
Press several times until the LED above lights up	

Enter Menu GTAW and enable 4RST option.

If 4-step restart is enabled from the setup menu the following sequence will occur for steps 3 and 4 (steps 1 and 2 are not altered by the restart option):

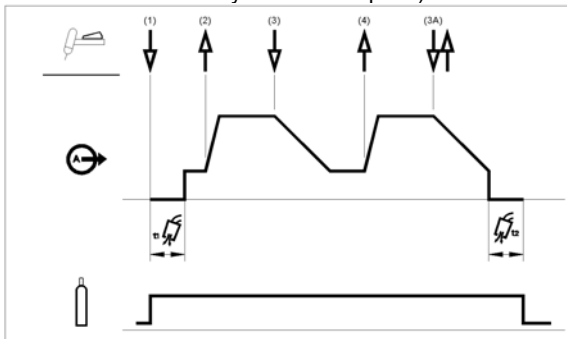

- Press and hold the TIG torch trigger. The machine will now decrease the output current at a controlled rate, or downslope time, until the Crater current is reached.
- Release the TIG torch trigger. The output current will again increase to the Welding current, like in step 2, to continue welding.

If the weld is completely finished, use the following sequence instead of step 3 described above.

- 3A. Quickly press and release the TIG torch trigger. The machine will now decrease the output current at a controlled rate, or downslope time, until the Crater current is reached and the output of the machine is turned OFF. After the arc is turned OFF the postflow time will start.

As shown here, after the TIG torch trigger is quickly pressed and released from step 3A, it is possible to press and hold the TIG torch trigger another time to end the downslope time and maintain the output current at the Crater current. When the TIG torch trigger is released the output will again increase to the Welding current, like in step 4, to continue welding. When the main part of the weld is complete go to step 3.

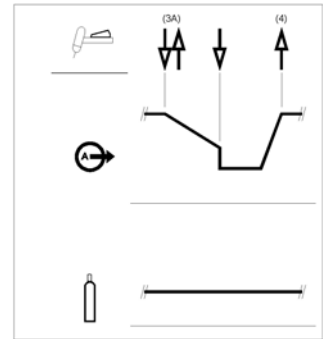

As shown here, again after the TIG torch trigger is quickly pressed and released from step 3A, it is possible to quickly press and release the TIG torch trigger a second time to end the downslope time and stop welding.

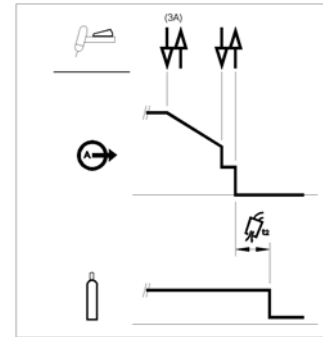

Spot TIG (GTAW welding)

Enter in Menu GTAW to enable spot welding function. When enabled, the spot tig function replaces the 2S trigger sequence.

To select Spot function:

Output	Visualization
Press until the LED above lights up	

This welding mode is especially thought to tack or weld thin materials.

It uses HF start and immediately it delivers the set current without any upslope/downslope.

When spot is selected automatically you have this setting:

- 2S without restart
- Working only in HF mode
- Upslope and downslope are disabled

When spot is selected in left display without any welding operation you can see the text:

S-0.0

While right displays shown the set current.

For default the spot time is 0s: that means the output current is delivered only when the trigger button is pushed.

The welding time is set with the spot time control and will be constant independently from the operation of the Trigger.



To set the spot time, user has to push SEL button until text SPT appears on the left display: turning now the main know is possible to set SPT time from 0 to 100s

Bi-Level (Set/A2) Trigger sequence

Enter Menu GTAW and enable BILV option.

When enabled, the bilevel tig function replaces the 4S trigger sequence.

To select Bi-Level sequence:

Output	Visualization
	

Press several times until the LED above lights up

When bilevel is selected in left display without any welding operation you can see the text:

B-0.0

With this sequence the arc is started as in the 4S sequence, this means that steps 1 and 2 are the same.

3. Quickly press and release the TIG torch trigger. The machine will switch the current level from Set to A2 (background current). Each time this trigger action is repeated the current level will switch between the two levels.

3A. Press and hold the TIG torch trigger when the main part of the weld is complete. The machine will now decrease the output current at a controlled rate, or downslope time, until the Crater current is reached. This Crater current can be maintained as long as necessary.



To set the A2 level, user has to push SEL button until text A2 appears on the left display: turning now the main know is possible to set A2 in percentage of the setting current.

NOTE: The Restart option and the Pulse function are not available for Bi-Level Trigger sequence

LIFT TIG ON sequence

When lift tig process is selected, it is possible to performe welding operation without the use of a trigger.



To select ON sequence:

Output	Visualization
	

Press several times until the LED above lights up

When the sequence is selected it is possible to start a weld with the lift method without pushing trigger. To end the weld it is necessary to break the arc. The parameter Starting current, Final slope and finishing current are ignored.

List of parameters and Factory stored programs

Function	Factory Configuration Default	Selectable Value Range 	Displayed parameter name	Displayed value
			<input type="text"/>	<input type="text"/>
Preflow	.5	0 - 25s (step 0.1s)	PRE	Current selected value (s)
Starting Current	100	10 – 200 % (step 1%)	STRT	Current selected value (%)
Initial slope	0.1	0 – 5s (step 0.1s)	UP	Current selected value (s)
Operating Amperage	50	2 – 300 A (step 1A) (TIG)		Current selected value (A)
		5 – 270 A (step 1A) (Stick)		
Final Slope	0	0 - 25s (step 0.1s)	DOWN	Current selected value (s)
Finishing Current	30	10 – 90 % (step 1%)	END	Current selected value (%)
Post flow	AUTO	0.1 - 60s (step 0.1s) Note A	POST	Current selected value (s)
Percent of Peak Current / Duty Cycle (Only when pulse function is enabled)	40	5-95 (step 5%) Note B	PEAK	% of FREQ
Pulses-Per-Second DC (Only when pulse function is enabled)	0.1	0,1 – 10 Hz (step 0.1Hz) 10 – 500Hz (step 1Hz) 500 – 2000Hz (step 10Hz)	FREQ	Current selected value (Hz)
Pulses-Per-Second AC (Only when pulse function is enabled)	0.1	0,1 – 10 Hz (step 0.1Hz) 10 – 100Hz (step 1Hz) Note C	FREQ	Current selected value (Hz)
Background Current (Only when pulse function is enabled)	25	10 -90 % (step 1%)	BACK	Current selected value (%)
SPOT time (Only when spot function is enabled)	0	0 – 10s (step 0.1s) 10 – 100s (step 1s)	SPT	Current selected value (s)
Low level background (Only when Bilevel function is enabled)	25	10 -90 % (step 1%)	A2	Current selected value (%)
AC Wave Balance				
Function	Factory Configuration Default	Selectable Value Range 	Displayed parameter name	Displayed value
			<input type="text"/>	<input type="text"/>
EN Offset	AUTO	2 – 300A (step 1A)	EN	Current selected value (A)
EP Offset	AUTO	2 – 300A (step 1A)	EP	Current selected value (A)
AC-Balance	AUTO	35 – 95 % (step 1%)	%BAL	Current selected value (%)
AC-Frequency	120	40 – 400Hz (step 1Hz)	FREQ	Current selected value (Hz)

Note A: When AUTO is selected means 1s/10A; minimum value is 3s.

Note B: for frequency value higher than 500Hz, PEAK is locked to 50%.

Note C: In AC polarity the pulse frequency is limited to 1/4 of the AC-frequency: if AC frequency is 120Hz that means the max pulse frequency is 30Hz. If the pulse frequency is higher than 1/10 of the AC frequency, the PEAK is fixed to 50%.

Advanced menu Menu GTAW

To enter into Menu GTAW see section Menu, described above

Menu GTAW

Function	Factory Configuration Default	Selectable Value Range 	Displayed parameter name	Displayed value
			V	A
Wave Form	SQRE	SOFT	WAVE	Current selected value type
		SINE		
		SQRE		
		TRI		
Tungstene size	AUTO	AUTO (Note D)	DIA	Current selected value
		0.5mm (0.02")		
		1mm (0.04")		
		1.6mm (1/16")		
		2.4mm (3/32")		
		3.2mm (1/8")		
		4mm (5/32")		
		ADV (Note E)		
Tungsten Type (Note F)*	GRN	GRN	TYPE	Current selected value Colour
		WHITE		
		GREY		
		TURQ		
		GOLD		
Restart 2S	OFF	ON/OFF	2RST	Current selected value (-)
Restart 4S	OFF	ON/OFF	4RST	Current selected value (-)
Bilevel function	OFF	ON/OFF	BILV	Current selected value (-)
Spot function	OFF	ON/OFF	SPOT	Current selected value (s)

TIG STARTING PARAMETERS				
Function	Factory Configuration Default	Selectable Value Range 	Displayed parameter name	Displayed value
			V	A
Polarity	EP	EN/EP	POL	Current selected value (-)
Amperage	120	2 – 200A (step 1A)	SCRT	Current selected value (A)
Time	100	1 – 1000ms (step 1ms)	STME	Current selected value (ms)
Start Slope Time	40	0 – 1000ms (step 1ms)	SSLP	Current selected value (ms)
Preset Amperage Min	5	2-50A (step 1A)	PCRT	Current selected value (A)

Note D. When AUTO is selected, the starting parameters are automatically recalled based on the set current adjustable by main knob in the front panel. Diameter of the electrode is automatically recalled based on the following table

User dialed weld I (AMP)	Tungsten diameter
> 227	3.2 mm
<=227 and > 153	2.4 mm
<=153 and > 67	1.6 mm
<=67 and > 27	1 mm
<=27	0.5 mm

4mm diameter starting parameters are never recalled when DIA = AUTO.

Note E. When ADV option is enabled, the user can create his personal starting setting according to "TIG AC starting parameters below).

Note F. This option is accessible only when a specific diameter is selected. When DIA = AUTO or DIA = ADV, that option is not visible.

WAVE-FORM selection

With this option is possible to select between four different waveforms

- "Soft" shape: to have a nice balance between a focused Arc and low noise.
- "Fast" shape: to have more focused arc.
- "Sin" Wave shape: comparable with older conventional machines, not very concentrated but very soft.
- "Triangle" shape: to reduce the amount of heat delivered to the workpiece.

Default setting: SQRE

Tungsten Size and Type

In order to ensure the maximum performance and arc striking reliability the operating parameters of the machine are automatically adjusted to the type and size of the tungsten electrode in use. Selecting the appropriate diameter of the electrode, automatically a recorder set of parameter is recalled to assure in both DC and AC mode a good are striking. For AC welding advanced users is present the possibility to modify the AC starting parameters

Tig AC starting parameters

The unit is delivered not allowing to the user to change starting parameters: for default option "Tig starting parameters", from now on TSTR, is selected in AUTO. When AUTO is selected for TSTR option, the value of the 4 parameters settable (SCRT, STME, SSLP and PCRT) and polarity (EP) are stored in unit and can be modified by the user .

Following picture show the meaning of the parameter for a local hand working. The ramp in SSLP time ends when STRT current level is reached: if STRT is lower than PCRT, the level will be PCRT.

Note: when PCRT is set in the range above, the minimum current delivered by the unit is PCRT level

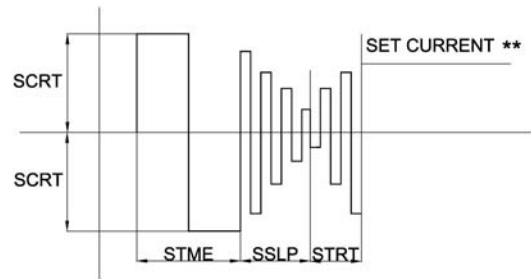

The starting sequence changes also if the foot paddle is present: in fact taking care of the STRT level is not settable, the level at the end of the SSLP ramp is the level from the footpaddle or the PCRT level.

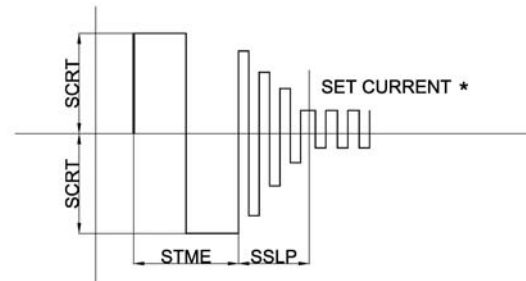

NOTE: the setting parameters stored assure the striking of the arc when correct electrode (diameter and colour) has been correctly selected.

In order to allow maximum flexibility to advanced users that need complete control over the welding process, the AC starting parameters can be modified by selecting MANL for the TSTR (Tig Starting Parameters) option in Menu C.

User can change polarity,

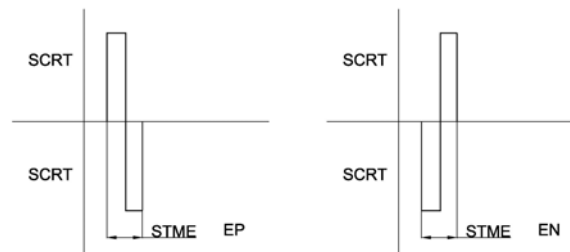

values of the other parameters creating its personal waveform for starting.

NOTE: the changing of the parameters above, could affect the striking of the arc if not correcting set.

Restart 2S, Restart 4S, Spot and Bilevel

See GTAW section above for details about mode of working.

Menu SMAW

To enter into Menu SMAW see section Menu, described above

Menu SMAW

Function	Factory Configuration Default	Selectable Value Range 	Displayed parameter name	Displayed value
			V	A
Arc Force	SOFT: 35%	0 – 75% (step 1%)	FRCE	Current selected value (%)
	CRISP: 75%	75 – 200% (step 1%)		
Hot Start	SOFT: 30%	0 – 75% (step 1%)	HSTR	Current selected value (%)
	CRISP: 50%	50 – 200% (step 1%)		
Stick Polarity	DC+	DC+ or DC-	STPL	Current selected value (-)

ARC FORCE and HOT START

With those two parameters, user can change the behaviour of unit in STICK DC stick welding. See DC stick welding for a better understanding of both features. Setting is ignored for AC STICK or GTAW mode of workin.

STICK POLARITY

With this function is possible to change polarity of the electrode clamp without any change in work cables connections. For default stick polairity is DC+.

Menu SYS

To enter into Menu SYS see section Menu, described above

Menu SYS

Function	Factory Configuration Default	Selectable Value Range 	Displayed parameter name V <input type="text"/>	Displayed value A <input type="text"/>
Units	mm	mm / INCH	UNIT	Current selected value (s)
VRD	OFF	ON/OFF	VRD	
LED Brightness/Intensity		LOW	LED	
	X	MED		
		HIGH		
TIG Remote Options	AMP	FOOT	RMTE	Current selected value type
		AMP		
Cooler option	AUTO	AUTO	COOL	Current selected value type
		ON		
Control firmware revision	N/A	N/A	CTRL	Current SW revision
UI firmware revision	N/A	N/A	UI	Current SW revision
Diagnostics	N/A	List of #'s	ERR	
Arc Time	-	105 hours	HOUR	Current selected value (hour)
Arc Counter	-	55 welds	CNT	Current selected value (welds)
Reset	N/A	YES/NO	RSET	

LED Brightness/Intensity

By this option is possible to select the intensity of the LEDs present in the user interface: three level can be selected by the user. High level is recommended when the unit is used outside with high sun light luminosity

Tig Remote options





This remote section in Menu SYS is dedicate to select the appropriate kind of remote devices connected. Unit detects itself the present of a remote devices (amptrol, footpaddle): selecting AMP you indicate the unit and amptrol is connected while selecting FOOT a footpaddle is conected. By default this selection is for AMP. The selection of FOOT and AMP changes dynamically also the possibility to select and change parameters as described in previous paragraphs.

COOLER option

This option permits to the user to activate permanently the water cooler when ON is selected. Cooler is switched OFF only in Idle state. For default AUTO is enable and the water cooler follows the timeline of welding, green mode and idle state. Cooler is switched OFF when green mode is activated; the entering in IDLE mode confirms the OFF status of Cooler.

Error Codes and troubleshooting.

If an error occurs, turn Off the machine, wait for a few seconds, then turn ON again. If the error remains, a maintenance is required. Please contact the nearest technical service center or Lincoln Electric and report the error code displayed on the meter of the Front Panel.

Err	Error code table
01	<p>Input voltage too low  LED is blinking. Indicates that an Input Undervoltage protection is active; the Machine restarts automatically when the Input Voltage returns in the correct range.</p>
02	<p>Input voltage too high  LED is blinking. Indicates that an Input Voltage Overvoltage protection is active; the Machine restarts automatically when the Input Voltage returns in the correct range.</p>
03	<p>Wrong input connection  LED blinking. Indicates that the machine is incorrectly wired or connected to a single phase mains supply. To restore the machine:</p> <ul style="list-style-type: none"> • Turn OFF the machine and check the input connection.
06	<p>Inverter voltage lock out  LED blinking. Indicates that an Internal Auxiliary Voltage fault condition is detected.</p> <p>To restore the machine:</p> <ul style="list-style-type: none"> • Turn OFF then ON the Mains Switch to restart the machine.
09	<p>Connection error This error message indicates the communication between Control and UI is not working.</p>
11	<p>Water cooler fault Cooler fluid is not correctly flowing through the torch. See the water cooler instruction manual for more details.</p>
12	<p>AC Switch Overload Indicates that an overload condition occurred. To restore the machine:</p> <ul style="list-style-type: none"> • Turn OFF then ON the Mains Switch to restart the machine.

Arc Time & Arc Counter

These two options show to the welder the total working hours and the total number of arc striking. To reset one or both registers, perform the following procedure:

- Select the option to reset;
- Push SEL button  for 5s. After that time the counter is reset: 0.0 presents in Voltage displays
- Release SEL Button

UI & CTRL firmware revision

By this option it is possible to see the current software revision in both UI and control board.

RESET

By this option an end user can reset all the settings present in the machine to factory default indicated in this manual for all parameters. Memory locations are not affected by this reset.

Maintenance

WARNING

For any maintenance or repair operations it is recommended to contact the nearest technical service center or Lincoln Electric. Maintenance or repairs performed by unauthorized service centers or personnel will null and void the manufacturer's warranty.

The frequency of the maintenance operations may vary in accordance with the working environment. Any noticeable damage should be reported immediately.

- Check cables and connections integrity. Replace, if necessary.
- Keep clean the machine. Use a soft dry cloth to clean the external case, especially the airflow inlet / outlet louvers.

WARNING

Do not open this machine and do not introduce anything into its openings. Power supply must be disconnected from the machine before each maintenance and service. After each repair, perform proper tests to ensure safety.

WEEE

07/06

English



Do not dispose of electrical equipment together with normal waste!
In observance of European Directive 2002/96/EC on Waste Electrical and Electronic Equipment (WEEE) and its implementation in accordance with national law, electrical equipment that has reached the end of its life must be collected separately and returned to an environmentally compatible recycling facility. As the owner of the equipment, you should get information on approved collection systems from our local representative.

By applying this European Directive you will protect the environment and human health!

Spare Parts

12/05

Part List reading instructions

- Do not use this part list for a machine if its code number is not listed. Contact the Lincoln Electric Service Department for any code number not listed.
- Use the illustration of assembly page and the table below to determine where the part is located for your particular code machine.
- Use only the parts marked "X" in the column under the heading number called for in the assembly page (# indicate a change in this printing).

First, read the Part List reading instructions above, then refer to the "Spare Part" manual supplied with the machine, that contains a picture-descriptive part number cross-reference.

Electrical Schematic

Refer to the "Spare Part" manual supplied with the machine.

Suggested Accessories

KIT-250A-35-5M	Cable kit 250A – 35mm ² – 5m
KIT-300A-50-5M	Cable kit 300A – 50mm ² – 5m
GRD-300A—50-xM	Ground cable 300A – 50mm ² – 5/10m
K10513-26-xM	Tig Torch LT 26G – 180A – 4/8m
K10513-18-xM	Tig Torch LT 18W – 320A – 4/8m
K10513-18SC-xM	Tig Torch LT 18SC W – 400A – 4/8m
K10513-20-xM	Tig Torch LT 20W – 220A – 4/8m
K14147-1	Remote Control 15m
K14105-1	Water Cooler COOLARC 46
K10420-1	Coolant Acorox (2x5l)
K14129-1	Cart TPX
K14148-1	Extension Cord 15m (*)
K870	Foot Amptrol.

(*) Only 2 Extension Cord for a maximum total length of 45m can be used.