

IM3184
10/2022
REV00

TOMAHAWK®30K & 45

OPERATOR'S MANUAL

ENGLISH



Lincoln Electric Bester Sp. z o.o.
ul. Jana III Sobieskiego 19A, 58-260 Bielawa, Poland
www.lincolnelectric.eu



THANK YOU! For choosing the QUALITY of the Lincoln Electric products.

- Please check packaging and equipment for damage. Claims for material damaged in shipment must be notified immediately to the dealer.
- For ease of use, please enter your product identification data in the table below. Model Name, Code & Serial Number can be found on the machine rating plate.

Model Name:	
.....	
Code & Serial number:	
.....	
Date & Where Purchased:	
.....	

ENGLISH INDEX

Technical Specifications.....	1
ECO design information.....	3
Electromagnetic Compatibility (EMC).....	5
Safety.....	6
Introduction.....	8
Installation and Operator Instructions.....	8
WEEE.....	17
Spare Parts.....	17
REACH.....	17
Authorized Service Shops Location.....	17
Electrical Schematic.....	17
Accessories.....	18
Connection configuration.....	19

Technical Specifications

NAME		INDEX		
TOMAHAWK®30K		K12038-3		
TOMAHAWK®45		K14391-1		
INPUT				
	Input Voltage U ₁	Input Power at Rated Output	EMC Class	Frequency
TOMAHAWK®30K	230V±15%	2,7 kW @ 100% Duty Cycle	A	50Hz
		3,3 kW @ 60% Duty Cycle		
TOMAHAWK®45	120V±15%	1,6 kW @ 100% Duty Cycle	A	50Hz
		2,4 kW @ 60% Duty Cycle		
	230V±15%	3,3 kW @ 100% Duty Cycle		
		4,6 kW @ 60% Duty Cycle		
		5,2 kW @ 45% Duty Cycle		
RATED OUTPUT AT 40°C				
	Duty Cycle (based on a 10 min. period)	Output Current	Output Voltage	
TOMAHAWK®30K	100%	25A	90Vdc	
	60%	30A	92Vdc	
TOMAHAWK®45 120V	100%	15A	86Vdc	
	60%	22A	88,8Vdc	
TOMAHAWK®45 230V	100%	30A	92Vdc	
	60%	40A	96Vdc	
	45%	45A	98Vdc	
OUTPUT RANGE				
	Cutting Current Range		Maximum Open Circuit Voltage	
TOMAHAWK®30K	15 – 30A		396Vdc	
TOMAHAWK®45 120V	15 – 22A		396Vdc	
TOMAHAWK®45 230V	15 – 45A		396Vdc	
EXTERNAL INLET COMPRESSED AIR				
	Required Inlet Flow Rate		Required Inlet Pressure	
TOMAHAWK®30K	125 ±10% l/min		5,0bar – 6,0bar	
TOMAHAWK®45	200 ±10% l/min		5,0bar – 6,0bar	
RECOMMENDED INPUT CABLE AND FUSE SIZES				
	Fuse (delayed) or Circuit Breaker ("D" characteristic) Size	Type of Plug (Included with Machine)	Input Power Cable	
TOMAHAWK®30K	16 A	SCHUKO 16A / 250V	3 x 1,5 mm ²	
TOMAHAWK®45K	16 A	SCHUKO 16A / 250V	3 x 2,5 mm ²	
PSYHICAL DIMENSION				
	Height	Width	Length (case only, without torch)	Weight
TOMAHAWK®30K	385 mm	215 mm	480 mm	18 – 18,5 kg
TOMAHAWK®45	385 mm	215 mm	480 mm	11,1 kg

OTHERS		
	Operating Temperature	Storage Temperature
TOMAHAWK®30K	from -10 °C to +40 °C	from -25 °C to 55°C
TOMAHAWK®45	from -10 °C to +40 °C	from -25 °C to 55°C
	Protection Rating	
TOMAHAWK®30K	IP23S	
TOMAHAWK®45		

ECO design information

The equipment has been designed in order to be compliant with the Directive 2009/125/EC and the Regulation 2019/1784/EU.

Efficiency and idle power consumption:

Index	Name	Efficiency when max power consumption / Idle power consumption	Equivalent model
K12038-3	TOMAHAWK®30K	84% / 43W	No equivalent model
K14391-1	TOMAHAWK®45	84% / 21W	No equivalent model

Idle state occurs under the condition specified in below table:

IDLE STATE	
Condition	Presence
MIG mode	
TIG mode	
STICK mode	
After 10 minutes of non-working	X
Fan off	

The value of efficiency and consumption in idle state have been measured by method and conditions defined in the product standard EN 60974-1:20XX.

Manufacturer's name, product name, code number, product number, serial number and date of production can be read from rating plate.

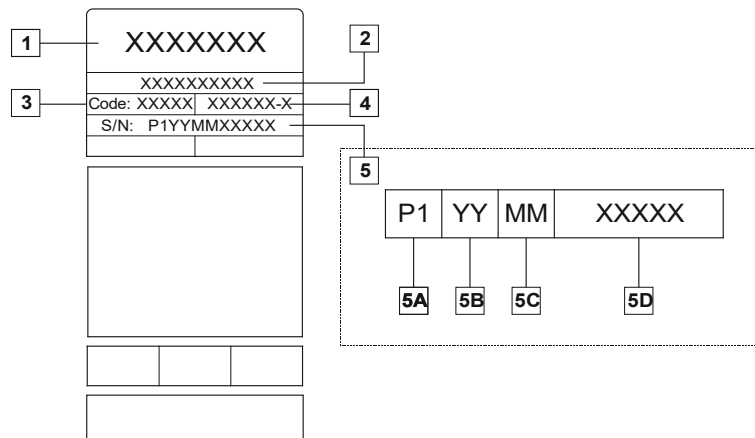

Where:

- 1- Manufacturer name and address
- 2- Product name
- 3- Code number
- 4- Product number
- 5- Serial number
 - 5A- country of production
 - 5B- year of production
 - 5C- month of production
 - 5D- progressive number different for each machine

Typical gas usage for **MIG/MAG** equipment:

Material type	Wire diameter [mm]	DC electrode positive		Wire Feeding [m/min]	Shielding Gas	Gas flow [l/min]
		Current [A]	Voltage [V]			
Carbon, low alloy steel	0,9 ÷ 1,1	95 ÷ 200	18 ÷ 22	3,5 – 6,5	Ar 75%, CO ₂ 25%	12
Aluminum	0,8 ÷ 1,6	90 ÷ 240	18 ÷ 26	5,5 – 9,5	Argon	14 ÷ 19
Austenic stainless steel	0,8 ÷ 1,6	85 ÷ 300	21 ÷ 28	3 - 7	Ar 98%, O ₂ 2% / He 90%, Ar 7,5% CO ₂ 2,5%	14 ÷ 16
Copper alloy	0,9 ÷ 1,6	175 ÷ 385	23 ÷ 26	6 - 11	Argon	12 ÷ 16
Magnesium	1,6 ÷ 2,4	70 ÷ 335	16 ÷ 26	4 - 15	Argon	24 ÷ 28

TIG Process:

In TIG welding process, gas usage depends on cross-sectional area of the nozzle. For commonly used torches:

Helium: 14-24 l/min
 Argon: 7-16 l/min

Notice: Excessive flow rates causes turbulence in the gas stream which may aspirate atmospheric contamination into the welding pool.

Notice: A cross wind or draft moving can disrupt the shielding gas coverage, in the interest of saving of protective gas use screen to block air flow.



End of life

At end of life of product, it has to be disposal for recycling in accordance with Directive 2012/19/EU (WEEE), information about the dismantling of product and Critical Raw Material (CRM) present in the product, can be found at <https://www.lincolnelectric.com/en-gb/support/Pages/operator-manuals-eu.aspx>

Electromagnetic Compatibility (EMC)

01/11

This machine has been designed in accordance with all relevant directives and standards. However, it may still generate electromagnetic disturbances that can affect other systems like telecommunications (telephone, radio, and television) or other safety systems. These disturbances can cause safety problems in the affected systems. Read and understand this section to eliminate or reduce the amount of electromagnetic disturbance generated by this machine.



This machine has been designed to operate in an industrial area. To operate in a domestic area it is necessary to observe particular precautions to eliminate possible electromagnetic disturbances. The operator must install and operate this equipment as described in this manual. If any electromagnetic disturbances are detected the operator must put in place corrective actions to eliminate these disturbances with, if necessary, assistance from

Lincoln Electric.

Before installing the machine, the operator must check the work area for any devices that may malfunction because of electromagnetic disturbances. Consider the following.

- Input and output cables, control cables, and telephone cables that are in or adjacent to the work area and the machine.
- Radio and/or television transmitters and receivers. Computers or computer controlled equipment.
- Safety and control equipment for industrial processes. Equipment for calibration and measurement.
- Personal medical devices like pacemakers and hearing aids.
- Check the electromagnetic immunity for equipment operating in or near the work area. The operator must be sure that all equipment in the area is compatible. This may require additional protection measures.
- The dimensions of the work area to consider will depend on the construction of the area and other activities that are taking place.

Consider the following guidelines to reduce electromagnetic emissions from the machine.

- Connect the machine to the input supply according to this manual. If disturbances occur it may be necessary to take additional precautions such as filtering the input supply.
- The output cables should be kept as short as possible and should be positioned together. If possible connect the work piece to ground in order to reduce the electromagnetic emissions. The operator must check that connecting the work piece to ground does not cause problems or unsafe operating conditions for personnel and equipment.
- Shielding of cables in the work area can reduce electromagnetic emissions. This may be necessary for special applications.

WARNING

The Class A equipment is not intended for use in residential locations where the electrical power is provided by the public low-voltage supply system. There may be potential difficulties in ensuring electromagnetic compatibility in those locations, due to conducted as well as radiated disturbances.



WARNING











While a high electromagnetic field occurs, a welding current can fluctuate.



WARNING

This equipment complies with IEC 61000-3-12.

WARNING

This equipment have to be used by qualified personnel. Be sure that all installation, operation, maintenance and repair procedures are performed only by qualified person. Read and understand this manual before operating this equipment. Failure to follow the instructions in this manual could cause serious personal injury, loss of life, or equipment damage. Read and understand the following explanations of the warning symbols. Lincoln Electric is not responsible for damages caused by improper installation, improper care or abnormal operation.

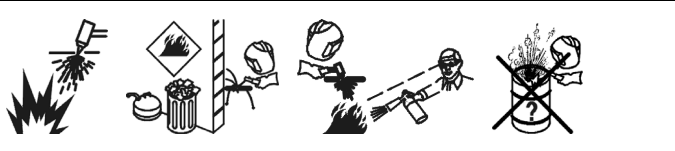
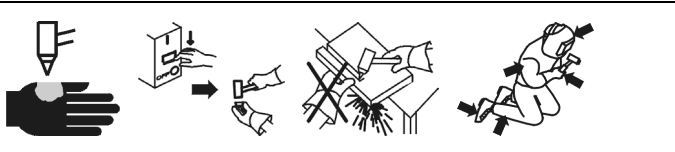
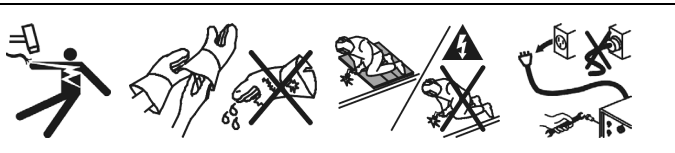
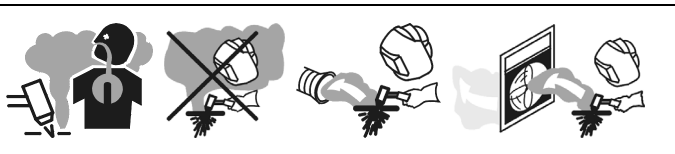
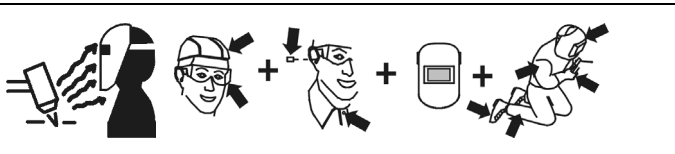
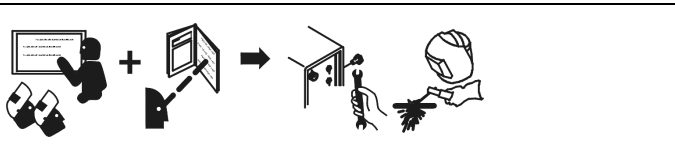
	<p>WARNING: This symbol indicates that instructions must be followed to avoid serious personal injury, loss of life, or equipment damage. Protect yourself and others from possible serious injury or death.</p>
	<p>READ AND UNDERSTAND INSTRUCTIONS: Read and understand this manual before operating this equipment. Plasma cutting can be hazardous. Failure to follow the instructions in this manual could cause serious personal injury, loss of life, or equipment damage.</p>
	<p>ELECTRIC SHOCK CAN KILL: Welding equipment generates high voltages. Do not touch the electrode, work clamp, or connected work pieces when this equipment is turned on. Insulate yourself from the electrode, work clamp, and connected work pieces.</p>
	<p>ELECTRICALLY POWERED EQUIPMENT: Turn off the input power using the disconnect switch at the fuse box before working on this equipment. Ground this equipment in accordance with local electrical regulations.</p>
	<p>ELECTRIC AND MAGNETIC FIELDS MAY BE DANGEROUS: Electric current flowing through any conductor creates electric and magnetic fields (EMF). EMF fields may interfere with some pacemakers, and welders having a pacemaker shall consult their physician before operating this equipment.</p>
	<p>CE COMPLIANCE: This equipment complies with the European Community Directives.</p>
	<p>ARTIFICIAL OPTICAL RADIATION: According with the requirements in 2006/25/EC Directive and EN 12198 Standard, the equipment is a category 2. It makes mandatory the adoption of Personal Protective Equipment (PPE) having filter with a protection degree up to a maximum of 15, as required by EN169 Standard.</p>
	<p>ARC RAYS CAN BURN: Use a shield with the proper filter and cover plates to protect your eyes from sparks and the rays of the arc when welding or observing. To protect the skin, use suitable clothing made of durable, fireproof material. Protect other nearby personnel with suitable, non-flammable screening and warn them not to watch the arc nor expose themselves to the arc.</p>
	<p>WORK MATERIALS CAN BURN: Cutting generates a large amount of heat. Hot surfaces and materials in work area can cause serious burns. Use gloves and pliers when touching or moving materials in the work area.</p>
	<p>CYLINDER MAY EXPLODE IF DAMAGED: Use only certificate, compressed gas cylinders containing the correct shielding gas for the process used and properly operating regulators designed for the gas and pressure used. Always keep cylinders in an upright position securely chained to a fixed support. Do not move or transport gas cylinders with the protection cap removed. Do not allow the electrode, electrode holder, work clamp or any other electrically live part to touch a gas cylinder. Gas cylinders must be located away from areas where they may be subjected to physical damage or the cutting process including sparks and heat sources.</p>

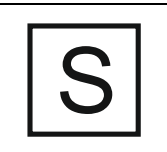
	<p>Cutting sparks can cause explosion or fire. Keep flammables away from cutting. Do not cut or gouge near flammables. Have a fire extinguisher nearby, and have a watch person ready to use it. Do not cut on drums or any closed container.</p>
	<p>The plasma arc can cause injury and burns. Keep your body away from nozzle and plasma arc. Turn off power before disassembling torch. Do not grip material near cutting path. Wear complete body protection.</p>
	<p>Electric shock from torch or wiring can kill. Wear dry insulating gloves. Do not wear wet or damaged gloves. Protect yourself from electric shock by insulating yourself from work and ground. Disconnect input plug or power before working on machine.</p>
	<p>Breathing cutting fumes can be hazardous to your health. Keep your head out of the fumes. Use forced ventilation or local exhaust to remove the fumes. Use ventilating fan to remove fumes.</p>
	<p>Arc rays can burn eyes and injure skin. Wear hat and safety glasses. Use ear protection and button shirt collar. Use welding helmet with correct shade of filter. To protect the skin, use suitable clothing made of durable, fireproof material.</p>
	<p>Become trained and read the instructions before working on the machine or cutting.</p>
	<p>Do not remove or paint over (cover) the label.</p>
	<p>SAFETY MARK: This equipment is suitable for supplying power for cutting operations carried out in an environment with increased hazard of electric shock.</p>

The manufacturer reserves the right to make changes and/or improvements in design without upgrade at the same time the operator's manual.

Introduction

TOMAHAWK®30K allows for cutting and grid.

The complete package **TOMAHAWK®30K** contains:

- Work lead – 6m,
- Cutting Plasma Hand Torch LC30 – 4m,
- USB user manual.

TOMAHAWK®30K has a built-in compressor that allow to operates in areas where an external primary air is not available.

Recommended equipment, which can be bought by user, was mentioned in the chapter "Accessories".

TOMAHAWK®45 allows for cutting, grid and gouging.

The complete package **TOMAHAWK®45** contains:

- Work lead – 6m,
- Cutting Plasma Hand Torch LC45 – 6m,
- USB user manual.

Recommended equipment, which can be bought by user, was mentioned in the chapter "Accessories".

Installation and Operator Instructions

Read this entire section before installation or operation of the machine.

Location and Environment

This machine will operate in harsh environments. However, it is important that simple preventative measures are followed to assure long life and reliable operation.

- Do not place or operate this machine on a surface with an incline greater than 15° from horizontal.
- Do not use this machine for pipe thawing.
- This machine must be located where there is free circulation of clean air without restrictions for air movement to and from the air vents. Do not cover the machine with paper, cloth or rags when switched on.
- Dirt and dust that can be drawn into the machine should be kept to a minimum.
- This machine has a protection rating of IP23S. Keep it dry when possible and do not place it on wet ground or in puddles.
- Locate the machine away from radio controlled machinery. Normal operation may adversely affect the operation of nearby radio controlled machinery, which may result in injury or equipment damage. Read the section on electromagnetic compatibility in this manual.
- Do not operate in areas with an ambient temperature greater than 40°C.

Duty Cycle

The duty cycle of a welding machine is the percentage of time in a 10 minute cycle at which the welder can operate the machine at rated welding current.

Example: 60% duty cycle:

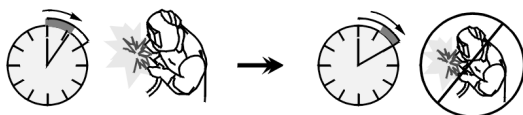

Cutting for 6 minutes.

Break for 4 minutes.

Excessive extension of the duty cycle will cause the thermal protection circuit to activate.

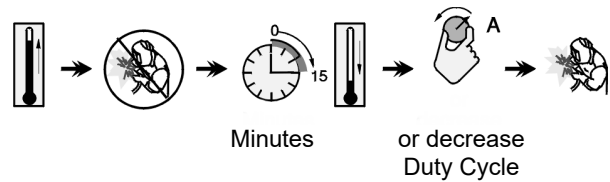

Input Supply Connection

! WARNING

Only a qualified electrician can connect the equipment to the supply network. Installation had to be made in accordance with the appropriate National Electrical Code and local regulations.

Check the input voltage, phase and frequency supplied to this machine before turning it on. Verify the connection of ground wires from the machine to the input source.

TOMAHAWK®30K & 45 must be connected to a correctly installed plug-in socket with an earth pin. Input voltage is:

- **TOMAHAWK®30K** 230Vac 50Hz;
- **TOMAHAWK®45** 120Vac, 230Vac 50Hz.

For more information about input supply refer to the technical specification section of this manual and to the rating plate of the machine.

Make sure that the amount of mains power available from the input supply is adequate for normal operation of the machine. The necessary delayed fuse or circuit breaker and cable sizes are indicated in the technical specification section of this manual.

! WARNING

The equipment can be supplied from a power generator of output power at least 30% larger than input power of the cutting machine.

! WARNING

When powering the machine from a generator be sure to turn off machine first, before generator is shut down, in order to prevent damage to equipment!

Controls and Operational Features

Front panel TOMAHAWK®30K

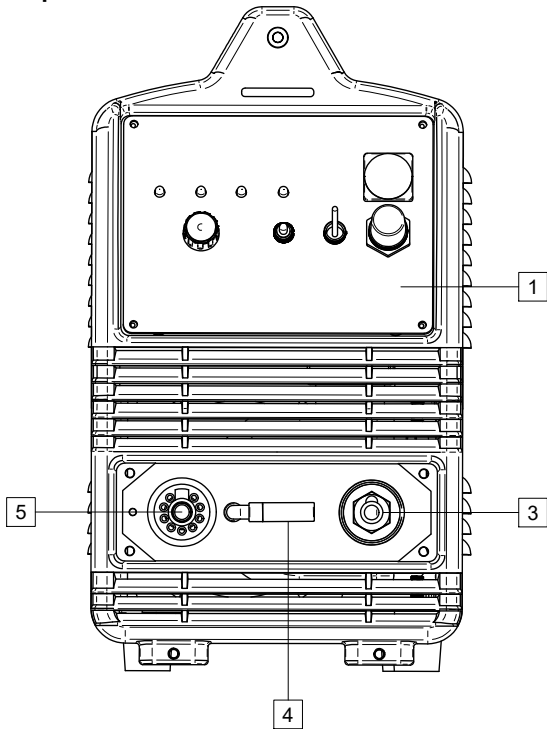

Figure 1

Front panel TOMAHAWK®45

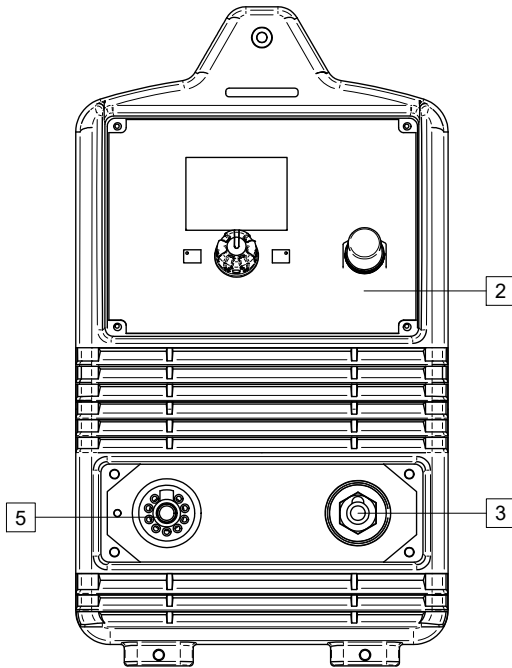

Figure 2

1. User Interface TOMAHAWK®30K: See User Interface TOMAHAWK®30K chapter.
2. User Interface TOMAHAWK®45: See User Interface TOMAHAWK®45 chapter.
3. Work Lead Connector.
4. Compressor Internal Air Filter: (TOMAHAWK®30K only).
5. Plasma Torch Connector.

Rear Panel TOMAHAWK®30K & 45

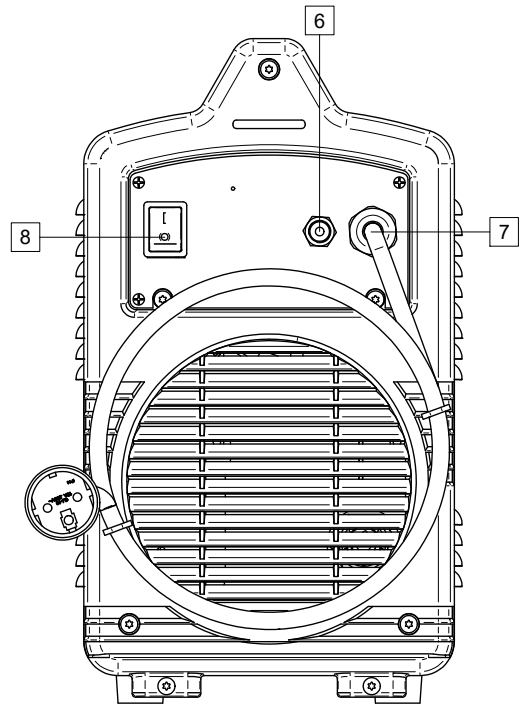

Figure 3

6. Air Connection Connector.
7. Input Cord 3m.
8. Power Switch ON/OFF (I/O): Controls the input power to the machine. Be sure the power source is properly connected to the mains supply before turning power on ("I"). See: Installation and Operator Instruction chapter.

User Interface TOMAHAWK®30K

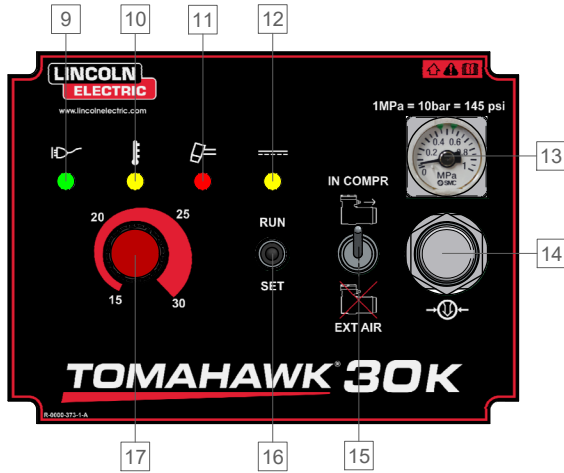











Figure 4

- 9. LED Indicator Power Switch: Lights up when the equipment is ON and connect to the power supply. 
- 10. Thermal LED: Lights up when the equipment is overheat. 
- 11. Connecting the torch: LED Indicator. Lights up when the torch is wrong connected to the connector [5] or the shield cup body is not tighten to the holder. 
- 12. LED Indicator: Lights up when the equipment is working. 
- 13. Manometer: Allows to read the air pressure. 
- 14. Purge Pressure Regulator Control: Allows to regulate the air pressure. 
- 15. Internal / External Air Switch: 

Symbol	Description
 IN COMPR	Internal compressor
 EXT AIR	External air network

- 16. RUN/SET Switch: In the “SET” you cannot cut.

Symbol	Description
SET	Purge test
RUN	Ready to cut

- 17. Output Current Control: Use to set the output current used during cutting.

User Interface TOMAHAWK®45

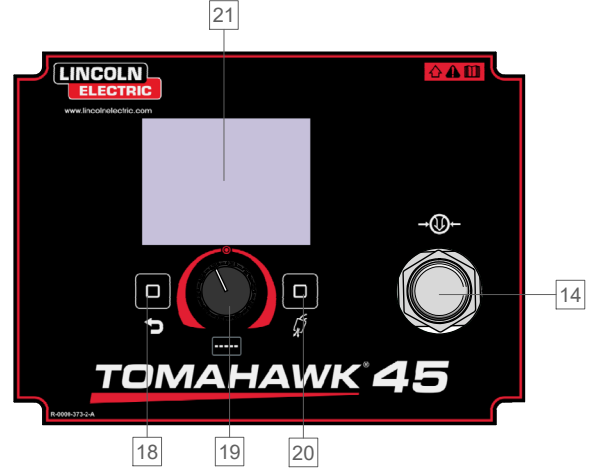





Figure 5

- 18. Home Button: Allows the user to return to the main view. 
- 19. Active Button Control: Used to select the available processes and their parameters, and to set the value current. 
- 20. Purge Test Button: Enables gas flow without turning on output voltage. 
- 21. LCD Display: Display shows processes and parameters.

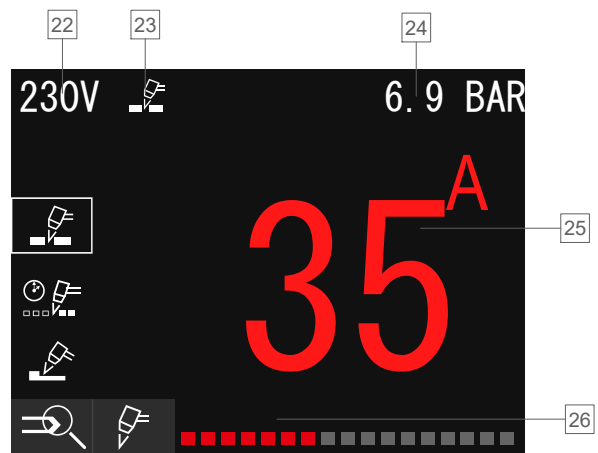

Figure 6

- 22. Supply Voltage: 120Vac or 230Vac. The equipment has a built-in detection of the supply voltage.

WARNING

Gouging is only possible with a 230Vac supply voltage! Output current range 30-45A.

- 23. Current Process: See „Table 1. User Setup Menu”.
- 24. Air Pressure. To set the air pressure, use the control [14].
- 25. Set Value Current: To set the value current, use the Active Button Control [19].

26. User Setup Menu: Displays the available processes and parameters.

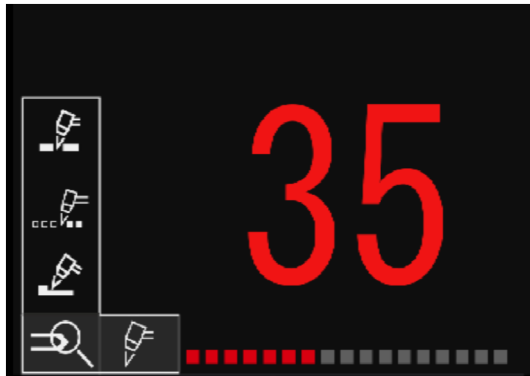

Figure 7

Table 1. User Setup Menu.

Symbol	Description
	Welding process / program selection
	Cutting
	Grid
	Gouging

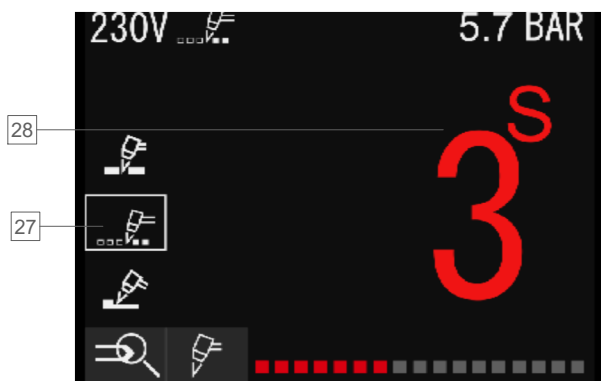

Figure 8

27. Selected grid process: To select a process, use the Active Button Control [19].

28. Pilot Current Backup Time Adjustment: Only for grid process.

Select Program

- Press the control [19], to get access of user setup menu.
- Press [19] again to display the available process. Select a process by turning the control and confirm the selection [19].
- For grid process you can adjust the pilot current time between 1-5 seconds. The default time is 3 seconds. Press the control [19] to confirm your selection.
- Press "Home" [18] to return to the main view.

TOMAHAWK®30K – cut, grid

After pressing the button in the torch:

- Preflow – purge flow before ignition of the pilot current – 2s (unalterable).
- Pilot current – maximum 3s, if it does not touch the material or the button in the torch is released, the pilot current will automatically turn off.
- Cutting current – proper cutting – lasts as long as the button in the torch is pressed.
- Pilot – sustaining the pilot current (grid process) – 3s. Is only possible when the button in torch is pressed. This enables the transition between the materials to be cut.
- Postflow – gas flow after cutting – 15s (unalterable).

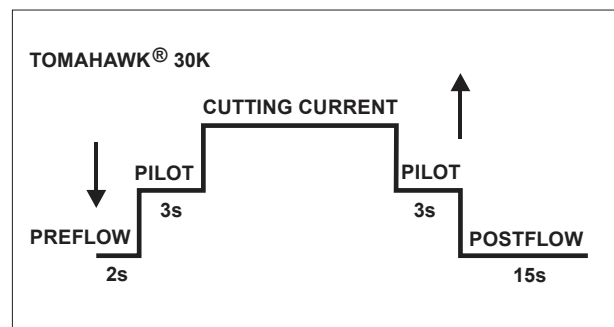

Figure 9

Table 2. TOMAHAWK®30K – Preflow/Postflow

Preflow	Current	Postflow
2 s	15-30 A	15 s

TOMAHAWK®45 – cut

After pressing the button in the torch:

- Prewflow – purge flow before ignition of the pilot current – 2s (unalterable).
- Pilot current – maximum 3s, if it does not touch the material or the button in the torch is released, the pilot current will automatically turn off.
- Cutting current – proper cutting – lasts as long as the button in the torch is pressed.
- Postflow – gas flow after cutting – time depends on the current – see Table 3.

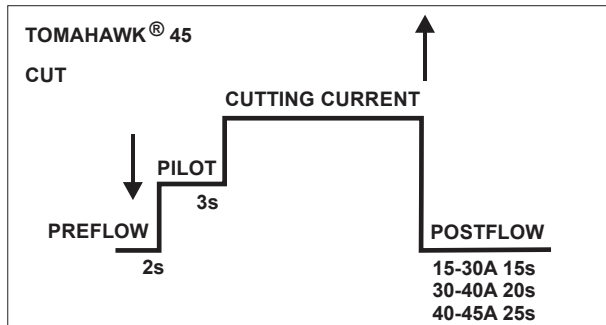

Figure 10

TOMAHAWK®45 – grid

After pressing the button in the torch:

- Prewflow – purge flow before ignition of the pilot current – 2s (unalterable).
- Pilot current – maximum 3s, if it does not touch the material or the button in the torch is released, the pilot current will automatically turn off.
- Cutting current – proper cutting – lasts as long as the button in the torch is pressed.
- Grid time – sustaining the pilot current, possible only the button in torch is pressed. Enables the transition between the materials to be cut. Adjustment range: 1 – 5s.
- Postflow – gas flow after cutting – time depends on the current – see Table 3.

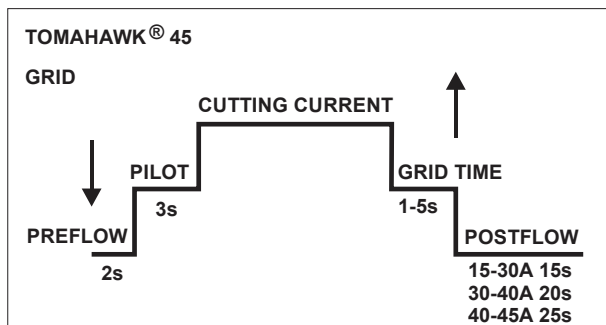

Figure 11

TOMAHAWK®45 – gouging

After pressing the button in the torch:

- Prewflow – purge flow before ignition of the pilot current – 2s (unalterable).
- Pilot current – maximum 3s, if it does not touch the material or the button in the torch is released, the pilot current will automatically turn off.
- Gouging current – lasts as long as the button in the torch is pressed.
- Pilot – sustaining the pilot current (grid process). Is only possible when the button in torch is pressed.
- Postflow – gas flow after gouging – 15s (unalterable).

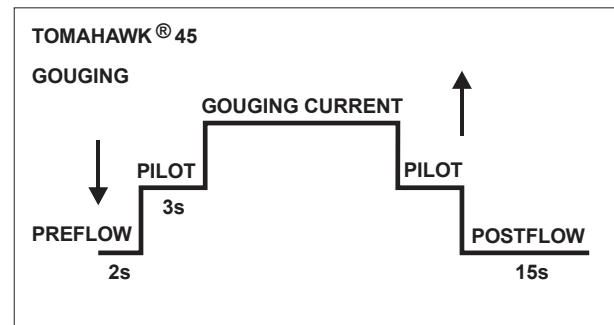

Figure 12

Table 3. TOMAHAWK®45 – Prewflow/Postflow

Prewflow	Current	Postflow
2s	15-30 A	15 s
	30-40 A	20 s
	40-45 A	25 s

Preparing the equipment

TOMAHAWK®30K enables the cutting and grid process.

WARNING

When preparing to work, make sure you have all materials needed to complete the work and have taken all safety precautions.

Procedure of begin of process:

- Turn the machine off.
- Connect the torch from the kit into the connector [5].
- Connect the work lead into the connector [3].
- Connect the other part of work lead to the material to be cut.
- Turn the machine on [8]. Check the LED [9] lights green and LED [11] is not lights red.
- Select a compressed air source [15].
- Select the airflow by switch [16] to "SET". Unlock the control [14] – pull control towards you and by turning to the right or left to set proper pressure.

WARNING

The recommended value pressure for high-quality cut is 5,5 bar for external mains.

WARNING

"Safety" function in torch – The button cover that prevents accidental ignition of the torch.

WARNING

The User cannot start the cutting process, if the starts the equipment with the button in the handle is pressed.

- Set the cutting current [17].
- The equipment is now ready.

WARNING

To start the cutting process just press the torch button, making sure you are not aiming the torch air blow towards people or foreign objects.

- By applying the principle of occupational health and safety, gouging can be begun.

TOMAHAWK®45 enables be cut, grid and gouging. **TOMAHAWK®45** does not include the accessories for gauging, but the one can be purchased separately (see "Accessories" chapter).

WARNING

When preparing to work, make sure you have all materials needed to complete the work and have taken all safety precautions.

Procedure of begin process:

- Turn the machine off.
- Connect the torch from the kit into the socket [5].
- Connect the work lead into the socket [3].
- Connect the other part of work lead to the material.
- Turn the machine on [8].
- Check the air pressure with the purge test button. Unlock the control [14] – pull control towards you and by turning to the right or left to set proper pressure.

WARNING

The recommended pressure value for a high-quality is 5,5 bar.

WARNING

"Safety" function in torch – The button cover that prevents accidental ignition of the torch.

WARNING

The User cannot start a process, if the starts the equipment with the button in the torch is pressed.

- Check process by Active Button Control [19]. For grid process you can adjust the plasma arc torch time between 1-5 seconds. The default time is 3 seconds. Press the control again to confirm your selection.

WARNING

Gouging is only possible with a 230V supply voltage! Output current range 30-45A.

- Press the "Home" button [18] to return to the main view.
- Set the cutting value by the control [19] and turn it to the left or right to set the value.
- The equipment is now ready.

WARNING

To start the process just press the torch button, making sure you are not aiming the torch air blow towards people or foreign objects.

- By applying the principle of occupational health and safety, process can be begun.

Cutting Speed

The cutting speed is a function of:

- Thickness and type of material to be cut.
- Value of set current. The current setting affects the quality of the cut edge.
- Geometrical shape of the cut (whether straight or curved).

In order to provide indications on the most suitable setting, the following table was established, based on tests performed on an automatic test-bench: the best results however can only be achieved from direct experience by the operator in his actual working conditions.

Table 4. Cutting Speed TOMAHAWK®30K

TOMAHAWK®30K				
Material Thickness (mm)	Speed (cm/min.)			
	Current(A)	Mild Steel	Stainless Steel	Aluminum
1	30	100,5	100,5	100,5
2		51,5	35,2	66,2
3		25	19,5	35,8
4		14,5	12,8	23,5
5		12	9,6	-
6		6	5,5	17,5
8		4	3,5	5,8
10		2,7	2,1	4,4
12		2	-	2,5
15		1,2	1,6	1,15
20		0,8	-	-

Table 5. Cutting Speed TOMAHAWK®45

TOMAHAWK®45							
Material Thickness (mm)	Speed (cm/min.)						
	Current (A)	Best Quality Settings			Production Setting		
		Steel	Stainless Steel	Aluminum	Steel	Stainless Steel	Aluminum
2	45	55,4	54,5	78,9	76,45	75,8	95,85
3		38,9	31,8	48,5	53,65	45,5	71,2
4		27,5	19,3	36,7	37,95	28,5	56,5
6		14	11,1	20,6	19,8	16,5	30,95
8		9,8	8,3	13,3	13,1	10,7	18,3
10		7,6	5,6	8,6	8,7	8	10,15
12		5,4	3,7	6,2	6,75	5,25	7,45
15		3	2,3	3,3	3,8	3,05	3,5
20		1,55	1,5	1,5	2,2	1,95	1,8
25		1	-	-	1,3	-	-

ERRORS

Table 6 Errors for TOMAHAWK®30K

Error code	Symptoms	Cause	Recommended Course of Action
Yellow	Overheat	<ul style="list-style-type: none"> Air flow is blocked. Fan is blocked. Faulty components in the equipment. 	<ul style="list-style-type: none"> Check for air pressure are correct. Check and correct condition of fan. turn off the equipment for at least 10 minutes. Make sure the equipment has not been operated beyond the Duty Cycle (refer to technology parameters). Choose the proper voltage (refer to technology parameters). Return for repair or have qualified technician repair per Service Manual.
Red	Cutting torch disconnection	<ul style="list-style-type: none"> The cutting torch is not properly connected to the socket [5] or the cutting torch is damaged. Shield cup body is damaged or incorrectly installed. 	<ul style="list-style-type: none"> Check the plasma torch is not damaged. Tighten the plasma cutting torch to the socket [5]. Tighten the shield cup body.

Table 7 Errors for TOMAHAWK®45

Error code	Symptoms	Cause	Recommended Course of Action
E01	Primary overheat	<ul style="list-style-type: none"> Air flow is blocked. Fan is blocked. Faulty components in the equipment. 	<ul style="list-style-type: none"> Check for air pressure are correct. Check and correct condition of fan. turn off the equipment for at least 10 minutes. Make sure the equipment has not been operated beyond the Duty Cycle (refer to technology parameters). Choose the proper voltage (refer to technology parameters). Return for repair or have qualified technician repair per Service Manual.
E02	Secondary overheat		
E09	Overheat		
E07	Primary NTC not connected		
E08	Primary NTC not connected		
E12	Lack of gas	<ul style="list-style-type: none"> Gas pressure is too low. Compressed air system fault. 	<ul style="list-style-type: none"> Check the compressed air system. Use the pressure regulator control to set the gas pressure as recommended in this manual.
E30	Cutting torch disconnection	<ul style="list-style-type: none"> The cutting torch is not properly connected to the socket [5] or the cutting torch is damaged. Shield cup body is damaged or incorrectly installed. 	<ul style="list-style-type: none"> Check the plasma torch is not damaged. Tighten the plasma cutting torch to the socket [5]. Tighten the shield cup body.

 **WARNING**

If for any reason you are unable to perform the recommended actions in the event of a fault, contact the nearest authorized Lincoln Electric service facility.

Maintenance

WARNING

For any repair operations, modifications or maintenances, it is recommended to contact the nearest Technical Service Center or Lincoln Electric. Repairs and modifications performed by unauthorized service or personnel will cause, that the manufacturer's warranty will be lost.

The frequency of the maintenance operations may vary in accordance with the working environment where the machine is placed.

Routine maintenance (everyday)

- Check condition of insulation and connections of the plasma cutting torch, work leads and insulation of input cord. If any insulation damage exists replace the lead immediately.
- Remove the spatters from the gas nozzle of the plasma cutting torch.
- Check condition and operation of the cooling fan. Keep clean its airflow slots!

Periodic maintenance (every 200 working hours but at least once a year)

Perform the routine maintenance and, in addition:

- Keep the equipment clean. Using a dry (and low pressure) airflow, remove the dust from the external case and from the cabinet inside.
- If it is required, clean and tighten plasma torch connector and work lead socket.
- Check cables and connections integrity. Replace, if necessary.
- Regularly clean the torch head, check its consumables and if necessary replace them.
- Regularly clean the compressor air filter.

WARNING

Before replacing wear parts or going into service operations, read the attached manual instruction of the torch.

WARNING

Do not open this equipment and do not introduce anything into its openings. Power supply must be disconnected from the machine before maintenance and service. After each repair, perform proper tests to check safety requirements.

Customer Assistance Policy

The business of The Lincoln Electric Company is manufacturing and selling high quality welding equipment, consumables, and cutting equipment. Our challenge is to meet the needs of our customers and to exceed their expectations. On occasion, purchasers may ask Lincoln Electric for advice or information about their use of our products. We respond to our customers based on the best information in our possession at that time. Lincoln Electric is not in a position to warrant or guarantee such advice, and assumes no liability, with respect to such information or advice. We expressly disclaim any warranty of any kind, including any warranty of fitness for any customer's particular purpose, with respect to such information or advice. As a matter of practical consideration, we also cannot assume any responsibility for updating or correcting any such information or advice once it has been given, nor does the provision of information or advice create, expand or alter any warranty with respect to the sale of our products.

Lincoln Electric is a responsive manufacturer, but the selection and use of specific products sold by Lincoln Electric is solely within the control of, and remains the sole responsibility of the customer. Many variables beyond the control of Lincoln Electric affect the results obtained in applying these types of fabrication methods and service requirements.

Subject to Change – This information is accurate to the best of our knowledge at the time of printing. Please refer to www.lincolnelectric.com for any updated information.

WEEE

07/06



Do not dispose of electrical equipment together with normal waste!

In observance of European Directive 2012/19/EC on Waste Electrical and Electronic Equipment (WEEE) and its implementation in accordance with national law, electrical equipment that has reached the end of its life must be collected separately and returned to an environmentally compatible recycling facility. As the owner of the equipment, you should get information on approved collection systems from our local representative.

By applying this European Directive you will protect the environment and human health!

Spare Parts

12/05

Part List reading instructions

- Do not use this part list for a machine if its code number is not listed. Contact the Lincoln Electric Service Department for any code number not listed.
- Use the illustration of assembly page and the table below to determine where the part is located for your particular code machine.
- Use only the parts marked "X" in the column under the heading number called for in the assembly page (# indicate a change in this printing).

First, read the Part List reading instructions above, then refer to the "Spare Part" manual supplied with the machine that contains a picture-descriptive part number cross-reference.

REACH

11/19

Communication in accordance with Article 33.1 of Regulation (EC) No 1907/2006 – REACH.

Some parts inside this product contain:

Bisphenol A, BPA,	EC 201-245-8, CAS 80-05-7
Cadmium,	EC 231-152-8, CAS 7440-43-9
Lead,	EC 231-100-4, CAS 7439-92-1
Phenol, 4-nonyl-, branched,	EC 284-325-5, CAS 84852-15-3

in more than 0,1% w/w in homogeneous material. These substances are included in the "Candidate List of Substances of Very High Concern for Authorisation" of REACH.

Your particular product may contain one or more of the listed substances.

Instructions for safe use:

- use according to Manufacturer instructions, wash hands after use;
- keep out of reach of children, do not put in mouth,
- dispose in accordance with local regulations.

Authorized Service Shops Location

09/16

- The purchaser must contact a Lincoln Authorized Service Facility (LASF) about any defect claimed under Lincoln's warranty period.
- Contact your local Lincoln Sales Representative for assistance in locating a LASF or go to www.lincolnelectric.com/en-gb/Support/Locator.

Electrical Schematic

Refer to the "Spare Part" manual supplied with the machine.

Accessories

TOMAHAWK®30K	
W100000325	TORCH LC-30 4M CEN. 5PIN LE
W100000355	GROUND CABLE 16MM 6M
W0300699A	CUTTING CIRCLE
W0200002	TWO-WHEELED UNDERCARRIAGE
W8800117R	FILTER CARTRIDGE

TOMAHAWK®45	
W100000327	TORCH LC-45 6M CEN. 5PIN LE
W100000355	GROUND CABLE 16MM 6M
W100000338	CUTTING CIRCLE
W0200002	TWO-WHEELED UNDERCARRIAGE
W8800117R	FILTER CARTRIDGE

Connection configuration

