

# LINC 405 & 635

---

## OPERATOR'S MANUAL



ENGLISH



Lincoln Electric Bester Sp. z o.o.  
ul. Jana III Sobieskiego 19A, 58-260 Bielawa, Poland  
[www.lincolnelectric.eu](http://www.lincolnelectric.eu)



**THANKS!** For having chosen the QUALITY of Lincoln Electric products.

- Please Examine Package and Equipment for Damage. Claims for material damaged in shipment must be notified immediately to the dealer.
- For future reference record in the table below your equipment identification information. Model Name, Code & Serial Number can be found on the machine rating plate.

Model Name:	
Code & Serial Number:	
Date & Where Purchased	

### ENGLISH INDEX

Technical Specifications.....	1
ECO design information .....	2
Electromagnetic Compatibility (EMC).....	4
Safety .....	5
Installation and Operator Instructions.....	7
WEEE.....	11
Spare Parts .....	11
Authorized Service Shops Location .....	11
Electrical Schematic.....	11
Suggested Accessories.....	12
Dimension Diagram.....	13

# Technical Specifications

NAME		INDEX		
LINC 405-SA		K14002-1		
LINC-405S		K14002-2		
LINC-405-SA		K14002-5		
LINC-635SA		K14038-1		
LINC-635S		K14038-2		
LINC-635S		K14038-4		
LINC-635SA		K14038-5		
LINC-635SAV		K14038-6		
INPUT				
Input Voltage	Input Power at Rated Output		Frequency	
230 / 400V ± 10% Three Phase	<b>405-S/SA</b>	34 kVA @ 35% Duty Cycle	50/60Hz	
	<b>635-S/SA</b>	54 kVA @ 35% Duty Cycle	50/60Hz	
RATED OUTPUT AT 40°C				
	Duty Cycle (Based on a 10 min. period)	Output Current	Output Voltage	
<b>405-S/SA:</b>	35%	400A	36.0 Vdc	
	60%	315A	33.0 Vdc	
	100%	240A	29.0 Vdc	
<b>635-S/SA</b>	35%	670A	44.0 Vdc	
	60%	500A	40.0 Vdc	
	100%	400A	36.0 Vdc	
OUTPUT RANGE				
	Welding Current Range	Maximum Open Circuit Voltage		
<b>405-S/SA:</b>	15A - 400A	78 Vdc		
<b>635-S/SA</b>	15A - 670A	78 Vdc		
RECOMMENDED INPUT CABLE AND FUSE SIZES				
	Fuse or Circuit Breaker Size	Input Power Cable		
<b>405-S/SA:</b>	63A (for 230V) Superlag	4 Conductor, 6mm <sup>2</sup>		
	40A (for 400V) Superlag			
<b>635-S/SA</b>	100A (for 230V) Superlag	4 Conductor, 16mm <sup>2</sup>		
	63A (for 400V) Superlag			
PHYSICAL DIMENSIONS				
	Height	Width	Length	Weight
<b>405-S/SA:</b>	640 mm (555 mm no wheels version)	580 mm	1150 mm (700 mm without handles)	126 kg
<b>635-S/SA</b>	670 mm (555 mm no wheels version)	580 mm	1150 mm (700 mm without handles)	150 kg
OTHERS				
Operating Temperature		Storage Temperature		
-10°C to +40°C		-25°C to +55°C		

# ECO design information

The equipment has been designed in order to be compliant with the Directive 2009/125/EC and the Regulation 2019/1784/EU.

Efficiency and idle power consumption:

Index	Name	Efficiency when max power consumption / Idle power consumption	Equivalent model
K14002-1	LINC 405-SA	63,9% / -	No equivalent model
K14002-2	LINC-405S	63,9% / -	No equivalent model
K14002-5	LINC-405-SA	63,9% / -	No equivalent model
K14038-1	LINC-635SA	71% / -	No equivalent model
K14038-2	LINC-635S	71% / -	No equivalent model
K14038-4	LINC-635S	71% / -	No equivalent model
K14038-5	LINC-635SA	71% / -	No equivalent model
K14038-6	LINC-635SAV	71% / -	No equivalent model

“-“ equipment doesn't have idle state.

The value of efficiency and consumption in idle state have been measured by method and conditions defined in the product standard EN 60974-1:20XX.

Manufacturer's name, product name, code number, product number, serial number and date of production can be read from rating plate.

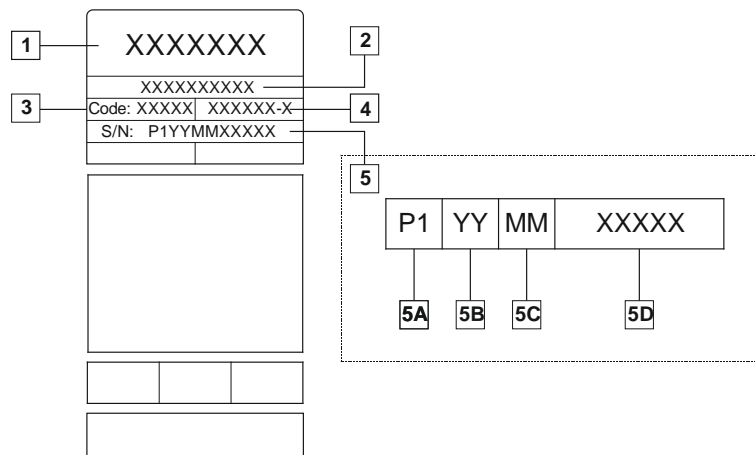

Where:

- 1- Manufacturer name and address
- 2- Product name
- 3- Code number
- 4- Product number
- 5- Serial number
  - 5A- country of production
  - 5B- year of production
  - 5C- month of production
  - 5D- progressive number different for each machine

Typical gas usage for **MIG/MAG** equipment:

Material type	Wire diameter [mm]	DC electrode positive		Wire Feeding [m/min]	Shielding Gas	Gas flow [l/min]
		Current [A]	Voltage [V]			
Carbon, low alloy steel	0,9 ÷ 1,1	95 ÷ 200	18 ÷ 22	3,5 – 6,5	Ar 75%, CO <sub>2</sub> 25%	12
Aluminium	0,8 ÷ 1,6	90 ÷ 240	18 ÷ 26	5,5 – 9,5	Argon	14 ÷ 19
Austenitic stainless steel	0,8 ÷ 1,6	85 ÷ 300	21 ÷ 28	3 - 7	Ar 98%, O <sub>2</sub> 2% / He 90%, Ar 7,5% CO <sub>2</sub> 2,5%	14 ÷ 16
Copper alloy	0,9 ÷ 1,6	175 ÷ 385	23 ÷ 26	6 - 11	Argon	12 ÷ 16
Magnesium	1,6 ÷ 2,4	70 ÷ 335	16 ÷ 26	4 - 15	Argon	24 ÷ 28

**Tig Process:**

In TIG welding process, gas usage depends on cross-sectional area of the nozzle. For commonly used torches:

Helium: 14-24 l/min.

Argon: 7-16 l/min.

**Notice:** Excessive flow rates causes turbulence in the gas stream which may aspirate atmospheric contamination into the welding pool.

**Notice:** A cross wind or draft moving can disrupt the shielding gas coverage, in the interest of saving of protective gas use screen to block air flow.



**End of life**

At end of life of product, it has to be disposal for recycling in accordance with Directive 2012/19/EU (WEEE), information about the dismantling of product and Critical Raw Material (CRM) present in the product, can be found at <https://www.lincolnelectric.com/en-gb/support/Pages/operator-manuals-eu.aspx>.

# Electromagnetic Compatibility (EMC)

11/04

This machine has been designed in accordance with all relevant directives and standards. However, it may still generate electromagnetic disturbances that can affect other systems like telecommunications (telephone, radio, and television) or other safety systems. These disturbances can cause safety problems in the affected systems. Read and understand this section to eliminate or reduce the amount of electromagnetic disturbance generated by this machine.



This machine has been designed to operate in an industrial area. To operate in a domestic area it is necessary to observe particular precautions to eliminate possible electromagnetic disturbances. The operator must install and operate this equipment as described in this manual. If any electromagnetic disturbances are detected the operator must put in place corrective actions to eliminate these disturbances with, if necessary, assistance from Lincoln Electric.

Before installing the machine, the operator must check the work area for any devices that may malfunction because of electromagnetic disturbances. Consider the following.

- Input and output cables, control cables, and telephone cables that are in or adjacent to the work area and the machine.
- Radio and/or television transmitters and receivers. Computers or computer controlled equipment.
- Safety and control equipment for industrial processes. Equipment for calibration and measurement.
- Personal medical devices like pacemakers and hearing aids.
- Check the electromagnetic immunity for equipment operating in or near the work area. The operator must be sure that all equipment in the area is compatible. This may require additional protection measures.
- The dimensions of the work area to consider will depend on the construction of the area and other activities that are taking place.

Consider the following guidelines to reduce electromagnetic emissions from the machine.

- Connect the machine to the input supply according to this manual. If disturbances occur it may be necessary to take additional precautions such as filtering the input supply.
- The output cables should be kept as short as possible and should be positioned together. If possible connect the work piece to ground in order to reduce the electromagnetic emissions. The operator must check that connecting the work piece to ground does not cause problems or unsafe operating conditions for personnel and equipment.
- Shielding of cables in the work area can reduce electromagnetic emissions. This may be necessary for special applications.









## **WARNING**



The Class A equipment is not intended for use in residential locations where the electrical power is provided by the public low-voltage supply system. There can be potential difficulties in ensuring electromagnetic compatibility in those locations, due to conducted as well as radio-frequency disturbances.



## **WARNING**

This equipment must be used by qualified personnel. Be sure that all installation, operation, maintenance and repair procedures are performed only by qualified person. Read and understand this manual before operating this equipment. Failure to follow the instructions in this manual could cause serious personal injury, loss of life, or damage to this equipment. Read and understand the following explanations of the warning symbols. Lincoln Electric is not responsible for damages caused by improper installation, improper care or abnormal operation.

	<p><b>WARNING:</b> This symbol indicates that instructions must be followed to avoid serious personal injury, loss of life, or damage to this equipment. Protect yourself and others from possible serious injury or death.</p>
	<p><b>READ AND UNDERSTAND INSTRUCTIONS:</b> Read and understand this manual before operating this equipment. Arc welding can be hazardous. Failure to follow the instructions in this manual could cause serious personal injury, loss of life, or damage to this equipment.</p>
	<p><b>ELECTRIC SHOCK CAN KILL:</b> Welding equipment generates high voltages. Do not touch the electrode, work clamp, or connected work pieces when this equipment is on. Insulate yourself from the electrode, work clamp, and connected work pieces.</p>
	<p><b>ELECTRICALLY POWERED EQUIPMENT:</b> Turn off input power using the disconnect switch at the fuse box before working on this equipment. Ground this equipment in accordance with local electrical regulations.</p>
	<p><b>ELECTRICALLY POWERED EQUIPMENT:</b> Regularly inspect the input, electrode, and work clamp cables. If any insulation damage exists replace the cable immediately. Do not place the electrode holder directly on the welding table or any other surface in contact with the work clamp to avoid the risk of accidental arc ignition.</p>
	<p><b>ELECTRIC AND MAGNETIC FIELDS MAY BE DANGEROUS:</b> Electric current flowing through any conductor creates electric and magnetic fields (EMF). EMF fields may interfere with some pacemakers, and welders having a pacemaker shall consult their physician before operating this equipment.</p>
	<p><b>CE COMPLIANCE:</b> This equipment complies with the European Community Directives.</p>
	<p><b>FUMES AND GASES CAN BE DANGEROUS:</b> Welding may produce fumes and gases hazardous to health. Avoid breathing these fumes and gases. To avoid these dangers the operator must use enough ventilation or exhaust to keep fumes and gases away from the breathing zone.</p>
	<p><b>ARC RAYS CAN BURN:</b> Use a shield with the proper filter and cover plates to protect your eyes from sparks and the rays of the arc when welding or observing. Use suitable clothing made from durable flame-resistant material to protect you skin and that of your helpers. Protect other nearby personnel with suitable, non-flammable screening and warn them not to watch the arc nor expose themselves to the arc.</p>

	<p><b>WELDING SPARKS CAN CAUSE FIRE OR EXPLOSION:</b> Remove fire hazards from the welding area and have a fire extinguisher readily available. Welding sparks and hot materials from the welding process can easily go through small cracks and openings to adjacent areas. Do not weld on any tanks, drums, containers, or material until the proper steps have been taken to insure that no flammable or toxic vapors will be present. Never operate this equipment when flammable gases, vapors or liquid combustibles are present.</p>
	<p><b>WELDED MATERIALS CAN BURN:</b> Welding generates a large amount of heat. Hot surfaces and materials in work area can cause serious burns. Use gloves and pliers when touching or moving materials in the work area.</p>
	<p><b>SAFETY MARK:</b> This equipment is suitable for supplying power for welding operations carried out in an environment with increased hazard of electric shock.</p>

The manufacturer reserves the right to make changes and/or improvements in design without upgrade at the same time the operator's manual.



# Installation and Operator Instructions

Read this entire section before installation or operation of the machine.

## Location and Environment

This machine will operate in harsh environments. However, it is important that simple preventative measures are followed to assure long life and reliable operation.

- Do not place or operate this machine on a surface with an incline greater than 15° from horizontal.
- Do not use this machine for pipe thawing.
- This machine must be located where there is free circulation of clean air without restrictions for air movement to and from the air vents. Do not cover the machine with paper, cloth or rags when switched on.
- Dirt and dust that can be drawn into the machine should be kept to a minimum.
- This machine has a protection rating of IP23. Keep it dry when possible and do not place it on wet ground or in puddles.
- Locate the machine away from radio controlled machinery. Normal operation may adversely affect the operation of nearby radio controlled machinery, which may result in injury or equipment damage. Read the section on electromagnetic compatibility in this manual.
- Do not operate in areas with an ambient temperature greater than 40°C.

## Duty cycle and Overheating

The duty cycle of a welding machine is the percentage of time in a 10 minute cycle at which the welder can operate the machine at rated welding current.

60% duty cycle:



Welding for 6 minutes.

Break for 4 minutes.

Excessive extension of the work duty cycle will cause the thermal protection circuit to activate.

The welding machine is protected from overheating by a thermostat. When the machine is overheated the output of the machine will turn "OFF", and the Thermal Indicator Light will turn "ON". When the machine has cooled to a safe temperature the Thermal Indicator Light will go out and the machine may resume normal operation.

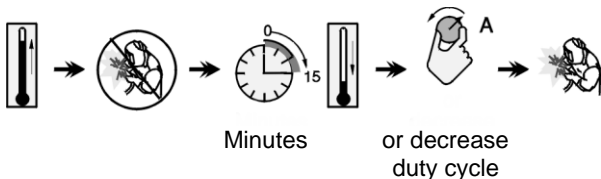

Minutes

or decrease  
duty cycle

## Input Supply Connection

Installation and mains outlet socket shall be made and protected according to appropriate rules.

Check the input voltage, phase, and frequency supplied to this machine before turning it on. Verify the connection of grounding wires from the machine to the input source. The allowable input voltages are 3x230V and 3x400V 50Hz (400V: factory default). For more information about input supply refer to the technical specification section of this manual and to the rating plate of the machine.

If it is necessary to change the main supply voltage:

- Ensure that the input cable must be disconnected from the main supply and the machine switched OFF.
- Remove the top panel from the machine.
- Reconnect X12 according to the diagram below.

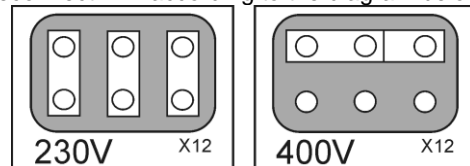

- Replace the top panel.

Make sure the amount of power available from the input connection is adequate for normal operation of the machine. The necessary delayed fuse (or circuit breaker with "D" characteristic) and cable sizes are indicated in the technical specification section of this manual.

Refer to points 1, 3, 12 and 13 of the images below.

## Output Connections

Refer to points 5, 10 and 11 of the images below.

## Controls and Operational Features

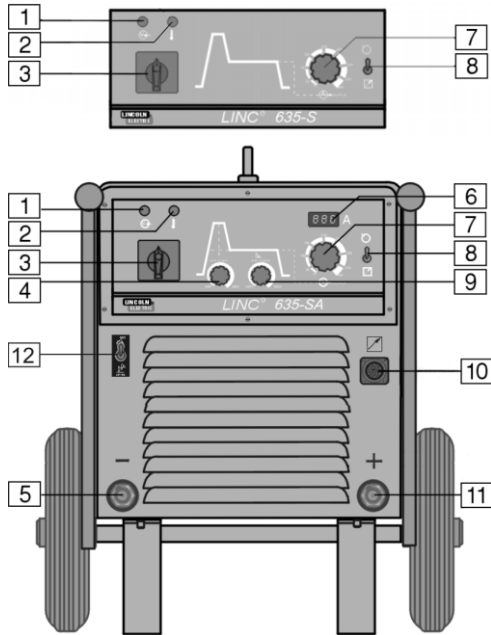

1. **Power Indicator:** After input power is connected and the power switch is turned on, this lamp will light up to indicate the machine is ready to weld.
2. **Thermal Overload Indicator:** This lamp will light up when the machine is overheated and the output has been turned off. This can occur if the ambient temperature is above 40°C or the duty cycle of the machine has been exceeded. Leave the machine on to allow the internal components to cool, when the lamp turns off normal operation is possible.
  - Thermostatic fan: the fan can be additionally controlled by the thermal protection circuit. In this mode **the fan is operating only while cooling is needed**. This feature saves energy and also minimizes the amount of dirt and other air borne particles being drawn into the machine. Thermostatic fan is switched off by factory default. If you want to activate it:
    - Ensure that the input cable must be disconnected from the main supply and the machine switched OFF.
    - Remove the top panel from the machine.
    - Reconnect X13 according to the diagram below:

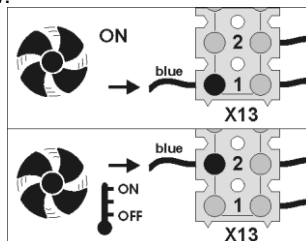

- Replace the top panel.

3. **Power on/off Switch:** Controls the input power to the machine.
4. **Hot Start Control (LINC ### -SA only):** Hot Start is a temporary increase in the output current during the start of stick (MMA) welding that helps ignite the arc quickly and reliably. The potentiometer is used to set the level of the increased current.
5. **Negative Quick Disconnect:** Negative output connector for the welding circuit.
6. **Digital Welding Current Meter with memory feature (LINC ### -SA only):** Shows present the value of the welding current during welding; after welding it continues to display the average welding current.
7. **Output Current Control:** Potentiometer used to set the output current (also during welding).
  - LINC 405: 15A ⇔ 400A
  - LINC 635: 15A ⇔ 670A
8. **Local/Remote Switch:** Remote Control Unit K10095-1-15M and K870 can be used with this machine. It changes control of the Output Current from the machine Output Control (point 7) to the K10095-1-15M or K870 and vice versa.
9. **Arc Force Control (LINC ### -SA only):** It is a function used during stick (MMA) welding in which the output current is temporarily increased to clear short circuit connections between the electrode and the weld puddle that occur during normal welding.
10. **Remote Control Connection:** If a remote control is used, it will be connected to the remote connector.
11. **Positive Quick Disconnect:** Positive output connector for the welding circuit.
12. **Mode Switch (LINC ### -SA only):** This switch changes the welding modes of the machine. The LINC ### -SA has two welding modes: Stick (MMA) and Lift TIG (GTAW).

When the mode switch is in the Stick position, the following welding features are enabled:

- Hot Start
- Arc Force
- Anti-Sticking: This is a function which decreases the output current of the machine to a low level when the operator makes an error and sticks the electrode to the work piece. This decrease in current allows the operator to remove the electrode from the electrode holder without creating large sparks which can damage the electrode holder.

When the mode switch is in the Lift TIG position, the stick welding functions are disabled and the machine is ready for Lift TIG welding. Lift TIG is a method of starting a TIG weld by first pressing the TIG torch electrode on the work piece in order to create a low current short circuit. Then, the electrode is lifted from the work piece to start the TIG arc

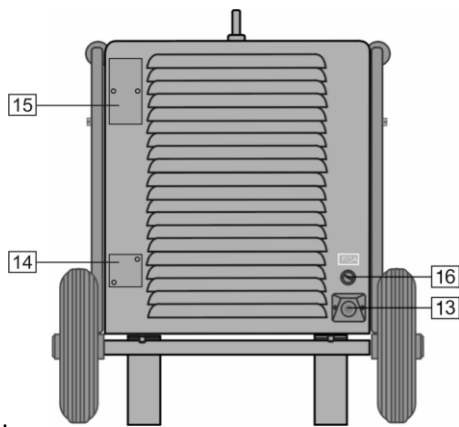

**LINC 405**

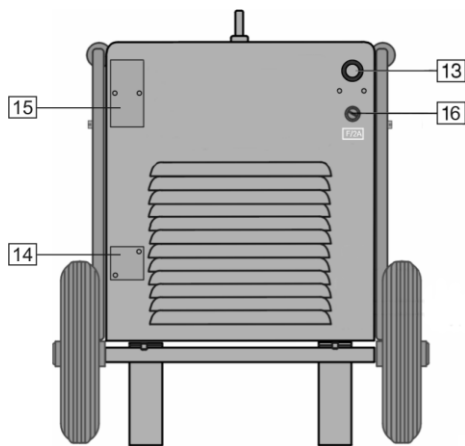

**LINC 635**

13. **Power Input Socket:** Connect the supply plug to the existing input cable, that is rated for the machine as indicated in this manual, and conforms to all applicable standards. This connection shall be performed only by a qualified person.
14. **Hole covered:** For 48Vac socket K14027-1.
15. **Hole covered:** For circuit breaker which protects the 48Vac socket K14027-1.
16. **Fuse:** This fuse protects the Fan Circuit.

## Stick Welding (MMA)

For starting welding process with MMA method you should:

- Insert welding cable plugs into output sockets and twist to lock them in place.
- Connect the work cable to the welding piece with the work clamp.
- Fasten a correct coated electrode into the electrode holder.
- Connect the main plug to the outlet mains socket.
- Set the Local/Remote Switch in required position: local or remote.
- Turn the Power on/off Switch on.
- Set required welding current by knob of the Output Current Control.
- Obeying appropriate rules you can begin to weld.

## Maintenance

### **WARNING**

For any maintenance or repair operations it is recommended to contact the nearest technical service center or Lincoln Electric. Maintenance or repairs performed by unauthorized service centers or personnel will null and void the manufacturers warranty.

The frequency of the minatenance operations may vary in accordance with the working environment where the machine is placed.

Any noticeable damage should be reported immediately.

### **Routine maintenance (everyday)**

- Check cables and connections integrity. Replace, if necessary.
- Check condition and operation of the cooling fan. Keep clean its airflow slots.

### **Periodic maintenance (every 200 working hours but not more rarely than once a year)**

Perform the routine maintenance and, in addition:

- Keep clean the machine. Using a dry ( and low pressure) airflow, remove the dust from the external case and from inside of the cabinet.
- Check and tighten all screws.

### **WARNING**

Mains supply network must be disconnected from the machine before each maintenance and service. After each repair, perform proper tests to ensure safety.

## **Customer Assistance Policy**

The business of The Lincoln Electric Company is manufacturing and selling high quality welding equipment, consumables, and cutting equipment. Our challenge is to meet the needs of our customers and to exceed their expectations. On occasion, purchasers may ask Lincoln Electric for advice or information about their use of our products. We respond to our customers based on the best information in our possession at that time. Lincoln Electric is not in a position to warrant or guarantee such advice, and assumes no liability, with respect to such information or advice. We expressly disclaim any warranty of any kind, including any warranty of fitness for any customer's particular purpose, with respect to such information or advice. As a matter of practical consideration, we also cannot assume any responsibility for updating or correcting any such information or advice once it has been given, nor does the provision of information or advice create, expand or alter any warranty with respect to the sale of our products

Lincoln Electric is a responsive manufacturer, but the selection and use of specific products sold by Lincoln Electric is solely within the control of, and remains the sole responsibility of the customer. Many variables beyond the control of Lincoln Electric affect the results obtained in applying these types of fabrication methods and service requirements.

Subject to Change – This information is accurate to the best of our knowledge at the time of printing. Please refer to [www.lincolnelectric.com](http://www.lincolnelectric.com) for any updated information

## WEEE

07/06

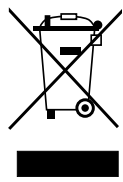

Do not dispose of electrical equipment together with normal waste!

In observance of European Directive 2012/19/EC on Waste Electrical and Electronic Equipment (WEEE) and its implementation in accordance with national law, electrical equipment that has reached the end of its life must be collected separately and returned to an environmentally compatible recycling facility. As the owner of the equipment, you should get information on approved collection systems from our local representative.

By applying this European Directive you will protect the environment and human health!

## Spare Parts

12/05

### Part List reading instructions

- Do not use this part list for a machine if its code number is not listed. Contact the Lincoln Electric Service Department for any code number not listed.
- Use the illustration of assembly page and the table below to determine where the part is located for your particular code machine.
- Use only the parts marked "X" in the column under the heading number called for in the assembly page (# indicate a change in this printing).

First, read the Part List reading instructions above, then refer to the "Spare Part" manual supplied with the machine, that contains a picture-descriptive part number cross-reference.

## Authorized Service Shops Location

09/16

- The purchaser must contact a Lincoln Authorized Service Facility (LASF) about any defect claimed under Lincoln's warranty period.
- Contact your local Lincoln Sales Representative for assistance in locating a LASF or go to [www.lincolnelectric.com/en-gb/Support/Locator](http://www.lincolnelectric.com/en-gb/Support/Locator).

## Electrical Schematic

Refer to the "Spare Part" manual supplied with the machine.

## Suggested Accessories

---

E/H-400A-70-5M	Welding Cable with the Holder for Coated Electrodes 5m.
GRD-400A-70-5M	Ground Cable with the Work Clamp 5m
GRD-600A-95-5M	Ground Cable with the Work Clamp 5m.
K10095-1-15M	Hand Amptrol.
K870	Foot Amptrol.
K14027-1	48Vac socket (1500W) kit.
K14039-1	Lift TIG welding kit (LINC ### -S only).

# Dimension Diagram

