

INVERTEC 165SX

OPERATOR'S MANUAL



ENGLISH



Lincoln Electric Bester Sp. z o.o.
ul. Jana III Sobieskiego 19A, 58-263 Bielawa, Poland
www.lincolnelectric.eu



THANKS! For having chosen the QUALITY of the Lincoln Electric products.

- Please Examine Package and Equipment for Damage. Claims for material damaged in shipment must be notified immediately to the dealer.
- For future reference record in the table below your equipment identification information. Model Name, Code & Serial Number can be found on the machine rating plate.

Model Name:
Code & Serial number:
Date & Where Purchased:

INDEX

Technical Specifications	1
Electromagnetic Compatibility (EMC)	2
Safety	3
Installation and Operator Instructions	5
WEEE	9
Spare Parts.....	9
Authorized Service Shops Location.....	9
Electrical Schematic	9
Accessories	9

Technical Specifications

PRIMARY SIDE	
	160 A
Single phase supply	230 V
Frequency	50/60 Hz
Effective consumption	15 A
Maximum consumption	21,5 A
Fuse	16 A
SECONDARY SIDE	
Open circuit voltage	48,4 V
Welding current	10 A ÷ 160 A
Duty cycle 30%	160 A
Duty cycle 60%	140 A
Duty cycle 100%	120 A
MISCELLEANOUS	
Protection class	IP 23
Insulation class	H
Weight	8,2 Kg
Dimensions	265 x 162 x 385 mm
European Standards	EN 60974.1 / EN 60974.10

Electromagnetic Compatibility (EMC)

01/11

This machine has been designed in accordance with all relevant directives and standards. However, it may still generate electromagnetic disturbances that can affect other systems like telecommunications (telephone, radio, and television) or other safety systems. These disturbances can cause safety problems in the affected systems. Read and understand this section to eliminate or reduce the amount of electromagnetic disturbance generated by this machine.



This machine has been designed to operate in an industrial area. The operator must install and operate this equipment as described in this manual. If any electromagnetic disturbances are detected the operator must put in place corrective actions to eliminate these disturbances with, if necessary, assistance from Lincoln Electric. This equipment is compliant with EN 61000-3-12 and EN 61000-3-11. It is the responsibility of the installer or user of the equipment to ensure, by consultation with the distribution network operator if necessary, that the system impedance complies with the impedance restrictions.

Before installing the machine, the operator must check the work area for any devices that may malfunction because of electromagnetic disturbances. Consider the following.

- Input and output cables, control cables, and telephone cables that are in or adjacent to the work area and the machine.
- Radio and/or television transmitters and receivers. Computers or computer controlled equipment.
- Safety and control equipment for industrial processes. Equipment for calibration and measurement.
- Personal medical devices like pacemakers and hearing aids.
- Check the electromagnetic immunity for equipment operating in or near the work area. The operator must be sure that all equipment in the area is compatible. This may require additional protection measures.
- The dimensions of the work area to consider will depend on the construction of the area and other activities that are taking place.

Consider the following guidelines to reduce electromagnetic emissions from the machine.

- Connect the machine to the input supply according to this manual. If disturbances occur it may be necessary to take additional precautions such as filtering the input supply.
- The output cables should be kept as short as possible and should be positioned together. If possible connect the work piece to ground in order to reduce the electromagnetic emissions. The operator must check that connecting the work piece to ground does not cause problems or unsafe operating conditions for personnel and equipment.
- Shielding of cables in the work area can reduce electromagnetic emissions. This may be necessary for special applications.















The Class A equipment is not intended for use in residential locations where the electrical power is provided by the public low-voltage supply system. There can be potential difficulties in ensuring electromagnetic compatibility in those locations, due to conducted as well as radio-frequency disturbances.





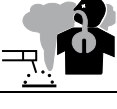



WARNING

This equipment must be used by qualified personnel. Be sure that all installation, operation, maintenance and repair procedures are performed only by qualified person. Read and understand this manual before operating this equipment. Failure to follow the instructions in this manual could cause serious personal injury, loss of life, or damage to this equipment. Read and understand the following explanations of the warning symbols. Lincoln Electric is not responsible for damages caused by improper installation, improper care or abnormal operation.

	<p>WARNING: This symbol indicates that instructions must be followed to avoid serious personal injury, loss of life, or damage to this equipment. Protect yourself and others from possible serious injury or death.</p>
	<p>READ AND UNDERSTAND INSTRUCTIONS: Read and understand this manual before operating this equipment. Arc welding can be hazardous. Failure to follow the instructions in this manual could cause serious personal injury, loss of life, or damage to this equipment.</p>
	<p>ELECTRIC SHOCK CAN KILL: Welding equipment generates high voltages. Do not touch the electrode, work clamp, or connected work pieces when this equipment is on. Insulate yourself from the electrode, work clamp, and connected work pieces.</p>
	<p>ELECTRICALLY POWERED EQUIPMENT: Turn off input power using the disconnect switch at the fuse box before working on this equipment. Ground this equipment in accordance with local electrical regulations.</p>
	<p>ELECTRICALLY POWERED EQUIPMENT: Regularly inspect the input, electrode, and work clamp cables. If any insulation damage exists replace the cable immediately. Do not place the electrode holder directly on the welding table or any other surface in contact with the work clamp to avoid the risk of accidental arc ignition.</p>
	<p>ELECTRIC AND MAGNETIC FIELDS MAY BE DANGEROUS: Electric current flowing through any conductor creates electric and magnetic fields (EMF). EMF fields may interfere with some pacemakers, and welders having a pacemaker shall consult their physician before operating this equipment.</p>
	<p>CE COMPLIANCE: This equipment complies with the European Community Directives.</p>
	<p>ARTIFICIAL OPTICAL RADIATION: According with the requirements in 2006/25/EC Directive and EN 12198 Standard, the equipment is a category 2. It makes mandatory the adoption of Personal Protective Equipment (PPE) having filter with a protection degree up to a maximum of 15, as required by EN169 Standard.</p>
	<p>FUMES AND GASES CAN BE DANGEROUS: Welding may produce fumes and gases hazardous to health. Avoid breathing these fumes and gases. To avoid these dangers the operator must use enough ventilation or exhaust to keep fumes and gases away from the breathing zone.</p>
	<p>ARC RAYS CAN BURN: Use a shield with the proper filter and cover plates to protect your eyes from sparks and the rays of the arc when welding or observing. Use suitable clothing made from durable flame-resistant material to protect you skin and that of your helpers. Protect other nearby personnel with suitable, non-flammable screening and warn them not to watch the arc nor expose themselves to the arc.</p>
	<p>WELDING SPARKS CAN CAUSE FIRE OR EXPLOSION: Remove fire hazards from the welding area and have a fire extinguisher readily available. Welding sparks and hot materials from the welding process can easily go through small cracks and openings to adjacent areas. Do not weld on any tanks, drums, containers, or material until the proper steps have been taken to insure that no flammable or toxic vapors will be present. Never operate this equipment when flammable gases, vapors or liquid combustibles are present.</p>
	<p>WELDED MATERIALS CAN BURN: Welding generates a large amount of heat. Hot surfaces and materials in work area can cause serious burns. Use gloves and pliers when touching or moving materials in the work area.</p>

	<p>SAFETY MARK: This equipment is suitable for supplying power for welding operations carried out in an environment with increased hazard of electric shock.</p>
	<p>CYLINDER MAY EXPLODE IF DAMAGED: Use only compressed gas cylinders containing the correct shielding gas for the process used and properly operating regulators designed for the gas and pressure used. Always keep cylinders in an upright position securely chained to a fixed support. Do not move or transport gas cylinders with the protection cap removed. Do not allow the electrode, electrode holder, work clamp or any other electrically live part to touch a gas cylinder. Gas cylinders must be located away from areas where they may be subjected to physical damage or the welding process including sparks and heat sources.</p>
	<p>WARNING: Stability of the equipment is guaranteed only for an incline of maximum 10°</p>
	<p>WARNING: Welding/cutting equipment must only be used for the purpose for which it is intended. It must never be used for any other purpose, such as battery charging, thawing out frozen water pipes, heating premises by the addition of heating elements, etc.</p>

The manufacturer reserves the right to make changes and/or improvements in design without upgrade at the same time the operator's manual.

Installation and Operator Instructions

Technical description

Description

The system consists of a modern direct current generator for the welding of metals, developed via application of the inverter. This special technology allows for the construction of compact light weight generators with high performance. Its adjust ability, efficiency and energy consumption make it an excellent work tool suitable for coated electrode and GTAW (TIG) welding).

Technical data

The machine can be connected to a motor generator of power meeting the data plate specifications and having the following characteristics:

- Output voltage between 185 and 275 Vac.
- Frequency between 50 and 60 Hz.

IMPORTANT: MAKE SURE THE POWER SOURCE MEETS THE ABOVE REQUISITES. EXCEEDING THE SPECIFIED VOLTAGE CAN DAMAGE THE WELDING MACHINE AND INVALIDATE THE WARRANTY.

Duty cycle and overheating

Duty cycle is the percentage of 10 minutes at 40°C ambient temperature that the unit can weld at its rated output without overheating. If the unit overheats, the output stops and the over temperature light comes On. To correct the situation, wait fifteen minutes for unit to cool. Reduce amperage, voltage or duty cycle before starting to weld again (See page III).

Volt - ampere curves

Volt-ampere curves show the maximum voltage and amperage output capabilities of the welding power source. Curves of other settings fall under curves shown (See page III).

Installation

Important: before connecting, preparing or using equipment, read safety precautions.

Connecting the power source to the mains electricity supply

SERIOUS DAMAGE TO THE EQUIPMENT MAY RESULT IF THE POWER SOURCE IS SWITCHED OFF DURING WELDING OPERATIONS.

Check that the power socket is equipped with the fuse indicated in the features label on the power source. All power source models are designed to compensate power supply variations. For variations of + 15% a welding current variation of +- 0,2% is created.



BEFORE INSERTING THE MAINS PLUG, IN ORDER TO AVOID THE FAIL OF POWER SOURCE, CHECK IF THE MAINS CORRESPONDS TO THE WISHED MAIN SUPPLY.

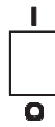

On - off switch: This switch has two positions: ON = I and OFF = O.

THIS CLASS A EQUIPMENT IS NOT INTENDED FOR USE IN RESIDENTIAL LOCATIONS WHERE THE ELECTRICAL POWER IS PROVIDED BY THE PUBLIC LOW-VOLTAGE SUPPLY SYSTEM. THERE MAY BE POTENTIAL DIFFICULTIES IN ENSURING ELECTROMAGNETIC COMPATIBILITY IN THOSE LOCATIONS, DUE TO CONDUCTED AS WELL AS RADIATED DISTURBANCES.

Connection and preparation of equipment for stick welding

TURN OFF WELDER BEFORE MAKING CONNECTIONS.

Connect all welding accessories securely to prevent power loss. Carefully follow safety precautions described.

- Fit the selected electrode to the electrode clamp.
- Connect the ground cable quick connection to the negative (-) receptacle and locate the clamp near the welding zone.
- Connect the electrode cable quick connection to the positive (+) receptacle.
- Use the above connection for straight polarity welding; for reverse polarity turn the connection.
- On the unit preset for coated electrode welding  (Ref.1 - Picture 1 Page 6.).
- Adjust welding current with ampere selector (Ref. 3 - Picture 1 Page 6.).
- Turn on the power source.

Connection and preparation of equipment for gas tungsten arc welding TIG

TURN OFF WELDER BEFORE MAKING CONNECTIONS.

Connect all welding accessories securely to prevent power loss. Carefully follow safety precautions described.

- On the unit preset Lift TIG welding  (Rif.1 - Picture 1 page 6.).
- Fit the required electrode and nozzle to the electrode holder (Check the protrusion and state of the electrode tip).
- Connect the ground cable quick connection to the positive (+) receptacle and the clamp near the welding zone.
- Connect the torch power cable connector to the negative receptacle (-).
- Connect the gas hose to the regulator located on the gas cylinder.
- Adjust welding current with ampere selector (Rif.3 - Picture 1 page 6.).
- Open the gas valve on the torch.
- Turn on the power source.

Functions

Front panel

Picture 1



Picture 2

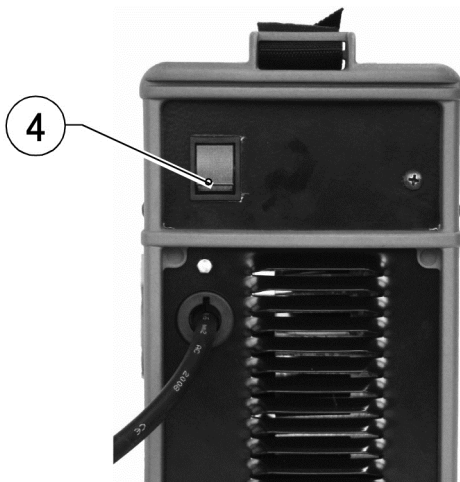

Process selector

(Rif.1 - Picture 1 page 6.). In this position welding can be used with rutile, basic electrodes, and specially coated electrodes.



Lift TIG procedure

In this position the TIG welding process with lift mode ignition can be selected, as described previously.

To ignite the arc

TIG welding, proceed as follows:

- Touch the welding piece with the electrode; this will cause a short circuit between the piece (2) and the electrode (1).
- Lift off the electrode; the arc will ignite.

The integrity of the electrode tip is guaranteed by the low ignition current during short-circuiting between the welding piece and the electrode ignition is guaranteed even at minimum welding current settings; the operator can therefore work without contaminating the ambient with electromagnetic disturbance, normally caused by

high frequency discharges.

The advantages can be summarized:

- no need for high-frequency startups,
- no damage to the electrode tip during start-ups, regardless of ampere setting, thereby avoiding the presence of tungsten in the welding piece, common during scratch starting.

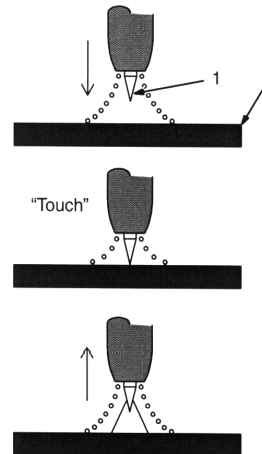

Fault led (Yellow)

(Rif.2 - Picture 1 page 6.). When the fault led lights on, the overheating occurs inside the unit due to the exceeding the rated duty cycle. Happening that the welding operations have to be stopped, the welding power source has to be kept on until the led lights off so the unit is ready to weld again.

Current regulation

(Rif.3 - Picture 1 page 6.). This potentiometer adjust the welding current range.

On - off switch

(Rif. 4 - Picture 2 page 6.). This switch has two positions: ON = I and OFF = O.

Arc led illuminated (Green)

(Rif.5 - Picture 1 page 6.). This led lights when the machine is turn on.

NOTE

The power source is fitted with an anti-sticking device that disables power if output short circuiting occurs or if the electrode sticks, allowing it to be easily detached from the work piece. This device enters into operation when power is supplied to the generator, even during the initial checking period, therefore any load input or short circuit that occurs during this phase is treated as a fault and will cause the output power to be disabled.

Troubleshooting procedure

Types of malfunctioning / welding faults – causes – remedies.

TYPES OF MALFUNCTIONING WELDING FAULTS	POSSIBLE CAUSES	CONTROLS AND REMEDIES
The generator does not weld: the digital switch is not lit.	The main switch is off. The power lead is interrupted (lack of one or two phases). Other.	Switch on mains. Verify and repair. Ask for the intervention of the Assistance Centre.
During welding suddenly the outgoing current is interrupted, the orange led goes on.	Overheating has occurred and the automatic protection has come on. (See work cycles).	Keep generator switched on and wait till temperature has dropped again (10-15 minutes) to the point where the orange switch goes off again.
Welding power reduced.	Outgoing wires are not correctly attached. A phase is missing.	Check that wires are intact, that the pliers are sufficient and that they are applied to welding surface clean from rust, paint or oils.
Excessive jets.	Welding arch too long. Welding current too high.	Wrong torch polarity, lower the current values.
Craters.	Fast removal of the electrodes.	
Inclusions.	Inadequate cleaning and bad distribution of coating. Faulty movement of the electrodes.	
Inadequate penetration.	Forward speed too high. Welding current too low.	
Sticking.	Welding arch too short. Current too low.	Increase current values.
Blowing and porosity.	Damp electrodes. Arch too long. Wrong torch polarity.	
Jacks.	Currents too high. Dirty materials.	
The electrode fuses in TIG.	Wrong torch polarity. Type of gas not suitable.	

Maintenance



NOTE

Disconnect power before maintenance. Maintenance must be carried out more frequently in heavy operating conditions.

Carry out the following operations every three (3) months:

- Replace any illegible labels.
- Clean and tighten the welding terminals.
- Replace damaged gas tubing.
- Repair or replace cracked cables and cords.

Carry out the following operations every six (6) months:

- Remove any dust inside the generator using a jet of dry air.
- Carry out this operation more frequently when working in very dusty places.

Handling and transporting the power source

OPERATOR SAFETY: WELDER'S HELMET - GLOWES - SHOES WITH HIGH INSTEPS.

THE WELDING POWER SOURCE DO NOT WEIGHT MORE THAN 25 KG AND CAN BE HANDLED BY THE OPERATOR. READ WELL THE FOLLOWING PRECAUTIONS.

The machine is easy to lift, transport and handle, though the following procedures must always be observed:

- The operations mentioned above can be operated by the handle on the power source.
- Always disconnect the power source and accessories from main supply before lifting or handling operations.
- Do not drag, pull or lift equipment by the cables.

Customer Assistance Policy

The business of The Lincoln Electric Company is manufacturing and selling high quality welding equipment, consumables, and cutting equipment. Our challenge is to meet the needs of our customers and to exceed their expectations. On occasion, purchasers may ask Lincoln Electric for advice or information about their use of our products. We respond to our customers based on the best information in our possession at that time. Lincoln Electric is not in a position to warrant or guarantee such advice, and assumes no liability, with respect to such information or advice. We expressly disclaim any warranty of any kind, including any warranty of fitness for any customer's particular purpose, with respect to such information or advice. As a matter of practical consideration, we also cannot assume any responsibility for updating or correcting any such information or advice once it has been given, nor does the provision of information or advice create, expand or alter any warranty with respect to the sale of our products.

Lincoln Electric is a responsive manufacturer, but the selection and use of specific products sold by Lincoln Electric is solely within the control of, and remains the sole responsibility of the customer. Many variables beyond the control of Lincoln Electric affect the results obtained in applying these types of fabrication methods and service requirements.

Subject to Change – This information is accurate to the best of our knowledge at the time of printing. Please refer to www.lincolnelectric.com for any updated information.

WEEE

07/06

English



Do not dispose of electrical equipment together with normal waste!

In observance of European Directive 2012/19/UE on Waste Electrical and Electronic Equipment (WEEE) and its implementation in accordance with national law, electrical equipment that has reached the end of its life must be collected separately and returned to an environmentally compatible recycling facility. As the owner of the equipment, you should get information on approved collection systems from our local representative.

By applying this European Directive you will protect the environment and human health!

Spare Parts

12/05

Part List reading instructions

- Do not use this part list for a machine if its code number is not listed. Contact the Lincoln Electric Service Department for any code number not listed.
- Use the illustration of assembly page and the table below to determine where the part is located for your particular code machine.
- Use only the parts marked "X" in the column under the heading number called for in the assembly page (# indicate a change in this printing).

First, read the Part List reading instructions above, then refer to the "Spare Part" manual supplied with the machine, that contains a picture-descriptive part number cross-reference.

Authorized Service Shops Location

09/16

- The purchaser must contact a Lincoln Authorized Service Facility (LASF) about any defect claimed under Lincoln's warranty period.
- Contact your local Lincoln Sales Representative for assistance in locating a LASF or go to www.lincolnelectric.com/en-gb/Support/Locator.

Electrical Schematic

Refer to the "Spare Part" manual supplied with the machine

Accessories

Consult the area agents or the dealer.